

CATÁLOGO

Geral de perfis

2026



ÍNDICE

TABELADOS	05-08
Tubos Redondos	06
Tubos Quadrados	06
Cantoneiras Abas Iguais	07
Tubos Retangulares	07
Barra Chata	08
Perfil U Abas Iguais	08
Perfil U Abas Desiguais	08
ARREMATES	09-10
CONTRA-MARCO	11-12
GRADIL E CORRIMÃO	13-17
ALUVIK G	18-35
ALUVIK S	36-48
LAMBRIS	49-53
LINHA 25	54-55
LINHA FACHADA	56-59
LINHA INTEGRADA	60-66
PORTÕES	67-69
SACADAS	70-72
TELHADOS	73-74
TEMPERADOS 10MM	75-78
TEMPERADOS 8MM	79-82
VENEZIANAS	83-84

ÍNDICE POR PERFIL

CÓDIGO	PESO (Kg/m)	PÁG.
2910	0,773	77
2911	0,325	77
2935	0,438	76
2936	0,365	78
2937	0,163	78
2938	0,331	78
2939	0,354	78
3074	0,095	77
3075	0,056	81
3172	0,193	81
25001	0,308	55
25002	0,339	55
25005	0,416	55
25508	0,692	55
25540	0,472	55
25542	0,601	55
25548	0,282	55
25504L	0,497	55
2910-BOX	0,607	82
2910-L	0,632	82
2911-BOX	0,208	81
2911-L	0,274	82
AG-002	0,639	19
AG-003	0,756	19
AG-004	2,035	23
AG-005	2,103	28
AG-006	0,675	19
AG-007	1,229	19
AG-015	0,147	19
AG-016	0,332	28
AG-017	1,009	27
AG-020	1,116	27
AG-021	1,734	26
AG-027	0,149	25
AG-028	0,455	20
AG-034	2,149	33
AG-035	1,089	66
AG-042	1,154	25
AG-043	0,935	25
AG-044	1,244	20
AG-047	1,133	20

CÓDIGO	PESO (Kg/m)	PÁG.
AG-048	0,973	21
AG-049	0,905	21
AG-050	0,817	21
AG-051	0,916	21
AG-052	1,667	26
AG-055	0,756	22
AG-056	0,642	25
AG-057	0,167	19
AG-059	0,168	22
AG-061	0,320	22
AG-062	1,729	22
AG-063	0,549	28
AG-066	1,539	23
AG-068	0,369	33
AG-070	2,222	30
AG-072	1,166	31
AG-074	0,791	29
AG-076	0,759	29
AG-077	0,327	33
AG-079	0,756	33
AG-083	0,385	29
AG-085	0,466	29
AG-091	0,160	29
AG-111	0,081	29
AG-125	1,008	33
AG-143	1,499	35
AG-157	0,253	29
AG-158	0,897	30
AG-160	2,085	34
AG-162	1,075	22
AG-176	1,531	27
AG-3158	1,014	24
AG-600	2,562	31
AG-601	2,769	32
AG-602	1,466	32
AG-640	1,277	34
AL-026	0,227	80
AL-027	0,160	80
AL-75	0,315	80
AS-001	0,713	44
AS-002	0,650	42

ÍNDICE POR PERFIL

CÓDIGO	PESO (Kg/m)	PÁG.
AS-003	0,490	43
AS-004	0,479	40
AS-005	1,092	37
AS-006	1,025	46
AS-007	0,385	43
AS-008	0,247	45
AS-009	0,896	37
AS-010	0,970	37
AS-011	0,967	41
AS-012	0,542	40
AS-013	0,707	38
AS-014	0,676	38
AS-018	0,630	43
AS-019	1,748	47
AS-039	0,526	44
AS-040	0,476	38
AS-041	0,506	38
AS-042	0,474	38
AS-047	1,046	39
AS-049	0,969	39
AS-053	0,472	44
AS-071	0,277	41
AS-079	0,341	42
AS-080	0,355	45
AS-082	0,382	45
AS-083	0,143	41
AS-084	0,114	39
AS-085	0,501	44
AS-086	0,586	40
AS-088	0,292	44
AS-102	0,110	43
AS-103	0,141	40
AS-104	0,101	48
AS-108	0,144	41
AS-111	0,621	45
AS-121	1,415	48
AS-122	1,407	48
AS-123	0,920	47
AS-200	0,409	45
AS-225	0,935	42
AS-227	0,505	46

CÓDIGO	PESO (Kg/m)	PÁG.
AS-228	0,609	47
AS-230	0,932	41
AS-242	0,712	39
AS-243	0,686	39
AS-245	0,639	43
AS-280	0,915	46
AS-291	0,263	40
BC-025	0,109	8
BC-060	0,218	8
BG-001	0,089	55
BX-059	0,243	80
BX-093	0,164	81
BX-104	0,149	81
BX-129	0,117	77
CEG-222	0,187	71
CEG-231	0,443	71
CEG-233	1,266	72
CEG-235	0,563	72
CEG-238	0,471	72
CEG-500	1,050	72
CG-003	0,469	14
CG-012	0,501	14
CG-021	0,321	14
CG-022	0,238	14
CG-074	0,268	15
CG-075	0,520	15
CG-077	0,840	15
CG-083	1,324	15
CL-006	1,108	24
CL-011	0,317	24
CM-060	0,269	12
CM-098	0,370	12
CM-151	0,307	12
CM-200	0,200	12
CT-005	0,128	7
CT-007	0,157	7
CT-016	0,211	7
CT-016ESC	0,208	80
CT-022	0,266	7
CT-026	0,321	7
CT-031	0,406	7

ÍNDICE POR PERFIL

CÓDIGO	PESO (Kg/m)	PÁG.
CX-124	0,900	76
CX-125	1,462	76
DES-259	0,155	39
DS-314	0,737	76
DV-113	0,253	84
FC-012	1,200	74
FC-013	0,221	74
FC-014	0,381	74
FSC-500	1,054	71
FSC-502	0,573	71
G-021	0,166	39
GR-U-01	4,972	17
GR-U-02	4,883	17
LB-001	0,626	50
LB-002	0,638	52
LB-002G	0,726	50
LB-036	0,592	53
LB-038	0,973	51
LB-075	0,931	53
LB-080	1,570	53
LB-600	0,669	53
LB-600G	1,072	51
ME-013	0,267	10
MN-001	1,375	65
MN-002	0,640	61
MN-003	0,971	64
MN-005	0,784	63
MN-006	0,878	64
MN-007	0,705	61
MN-014	0,420	66
MN-015	0,723	61
MN-030	1,643	62
MN-031	1,330	63
MN-032	1,653	62
MN-039	1,215	65
MN-050	0,733	63
MN-055	0,366	61
MP-347	0,220	10
PC-002	0,520	14
PC-003	0,777	16
PC-004	0,795	14

CÓDIGO	PESO (Kg/m)	PÁG.
PC-006	0,386	68
PC-010	0,929	68
PC-072	1,467	16
PC-601	2,979	69
PC-602	1,174	68
PU-004	0,190	8
PU-009	0,154	81
PU-009L	0,111	82
PU-048	0,409	82
PU-207	0,230	8
PU-329	0,251	8
TG-001	0,213	7
TG-004	0,405	7
TG-005	0,608	7
TG-027	0,905	7
TG-072	1,608	7
TG-072L	0,976	7
TG-072P	2,380	7
TG-073	0,569	7
TG-073L	0,402	7
TG-155	1,627	7
TG-155P	3,206	7
TQ-009	0,315	6
TQ-013	0,480	6
TQ-017	0,801	6
TQ-034	2,158	6
TR-018	0,154	6
TR-070	0,377	6
TR-098	0,665	6
VZ-006	0,304	84
VZ-024	0,231	84
VZ-047	0,268	84
VZ-060	0,377	84
XA-200	1,952	58
XA-211	0,937	57
XA-227	0,264	57
XA-230	0,769	57
XA-231	0,387	57
XA-245	0,744	57
XA-247	0,191	59
XA-515	1,479	59



TABELADOS

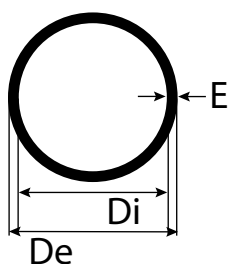

TUBOS REDONDOS

TUBOS REDONDOS		DIMENSÕES					PESO (Kg/m)
CÓDIGO	CÓD. MERC.	MILÍMETROS			POLEGADAS		
		De	Di	E	De	E	
TR-018	TR 3/4" x 1,00	19,05	17,05	1,00	3/4	-	0,154
TR-070	TR 1.1/2" x 1,20	38,10	35,70	1,20	1.1/2	-	0,377
TR-098	TR 2" x 1/16"	50,80	47,64	1,58	2	1/16	0,665

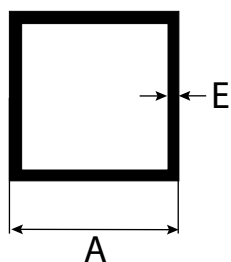

TUBOS QUADRADOS

TUBOS QUADRADOS		DIMENSÕES				PESO (Kg/m)
CÓDIGO	CÓD. MERC.	MILÍMETROS		POLEGADAS		
		A	E	A	E	
TQ-009	TQ 1" x 1,20	25,40	1,20	1	-	0,315
TQ-034	TQ 4" x 4" x 2,00	101,60	2,00	4	-	2,158
TQ-013	TQ 1.1/2" x 1,20	38,10	1,20	1.1/2	-	0,480
TQ-017	TQ 2" x 1,50	50,80	1,50	2	-	0,801

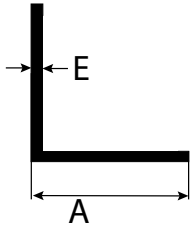

CANTONEIRAS ABAS IGUAIS

CANTONEIRAS ABAS IGUAIS		DIMENSÕES				PESO (Kg/m)
CÓDIGO	CÓD. MERC.	MILÍMETROS		POLEGADAS		
		A	E	A	E	
CT-005	CT 5/8" x 1/16"	15,88	1,58	5/8	1/16	0,128
CT-007	CT 3/4" x 1/16"	19,05	1,58	3/4	1/16	0,157
CT-016	CT 1" x 1/16"	25,40	1,58	1	1/16	0,211
CT-022	CT 1.1/4" x 1/16"	31,75	1,59	1.1/4	1/16	0,266
CT-026	CT 1.1/2" x 1/16"	38,10	1,59	1.1/2	1/16	0,321
CT-031	CT 2" x 1,50	50,80	1,50	2	-	0,406

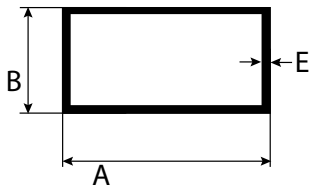

TUBOS RETANGULARES

TUBOS RETANGULARES		DIMENSÕES						PESO (Kg/m)
CÓDIGO	CÓD. MERC.	MILÍMETROS			POLEGADAS			
		A	B	E	A	B	E	
TG-001	TRG 1" x 1/2" x 1,10	25,40	12,70	1,10	1	1/2	-	0,213
TG-004	TRG 2" x 1/2" x 1,20 LISO	50,80	12,70	1,20	2	1/2	-	0,405
TG-073L	TRG 2" x 1" x 1,00 LISO	50,80	25,40	1,00	2	1	-	0,402
TG-073	TRG 2" x 1" x 1,50	50,80	25,40	1,50	2	1	-	0,569
TG-005	TRG 2" x 1.1/2" x 1,30 LISO	50,80	38,10	1,30	2	1.1/2	-	0,608
TG-027	TRG 3" x 1.1/2" x 1,50 LISO	76,20	38,10	1,50	3	1.1/2	-	0,905
TG-072L	TRG 4" x 2" x 1,20	101,60	50,80	1,20	4	2	-	0,976
TG-072	TRG 4" x 2" x 2,00	101,60	50,80	2,00	4	2	-	1,608
TG-072P	TRG 4" x 2" x 3,00	101,60	50,80	3,00	4	2	-	2,380
TG-155	TRG 6" x 2" x 1,50	152,40	50,80	1,50	6	2	-	1,627
TG-155P	TRG 6" x 2" x 3,00	152,40	50,80	3,00	6	2	-	3,206

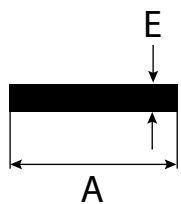

BARRA CHATA

BARRA CHATA		DIMENSÕES				PESO (Kg/m)
CÓDIGO	CÓD. MERC.	MILÍMETROS		POLEGADAS		
		A	E	A	E	
BC-025	BC 1" x 1/16"	25,40	1,59	1	1/16	0,109
BC-060	BC 2" x 1/16"	50,80	1,58	2	1/16	0,218

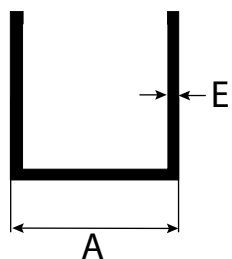

PERFIL U ABAS IGUAIS

PERFIL U ABAS IGUAIS		DIMENSÕES				PESO (Kg/m)
CÓDIGO	CÓD. MERC.	MILÍMETROS		POLEGADAS		
		A	E	A	E	
PU-004	U 5/8" x 1/16"	15,88	1,58	5/8	1/16	0,190
PU-207	U 3/4" x 1/16"	19,05	1,58	3/4	1/16	0,230

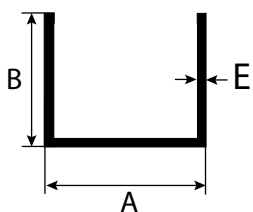

PERFIL U ABAS DESIGUAIS

PERFIL U ABAS DESIGUAIS		DIMENSÕES						PESO (Kg/m)
CÓDIGO	CÓD. MERC.	MILÍMETROS			POLEGADAS			
		A	B	E	A	B	E	
PU-329	U 19/32" x 1" x 1/16"	15,00	25,00	1,59	19/32	1	1/16	0,251



ARREMATES

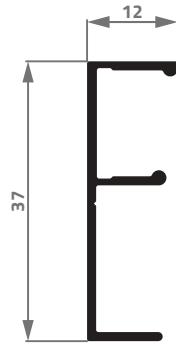

MP-347
0,220 Kg/m

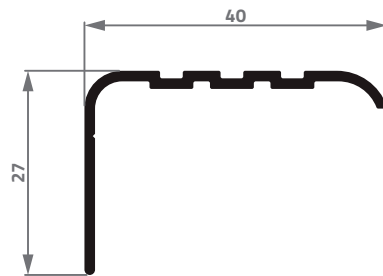

ME-013
0,267 Kg/m



CONTRA-MARCO

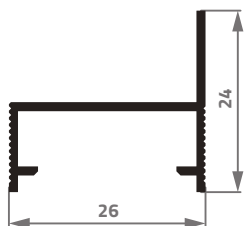

CM-200
0,200 Kg/m

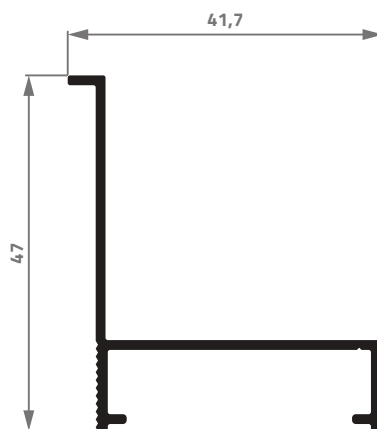

CM-098
0,370 Kg/m

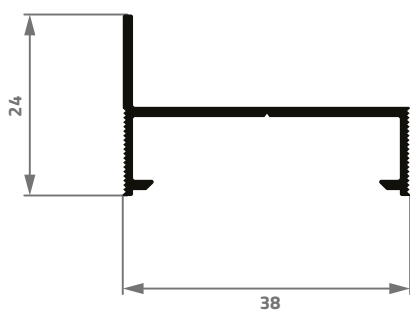

CM-060
0,269 Kg/m

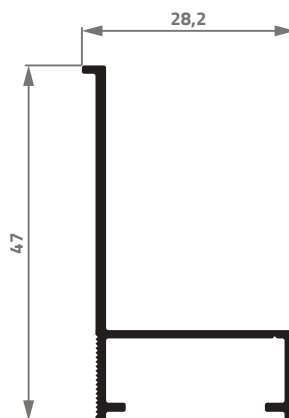

CM-151
0,307 Kg/m



GRADIL E CORRIMÃO

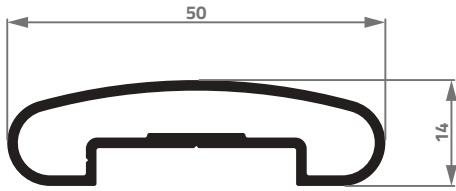

CG-003
0,469 Kg/m

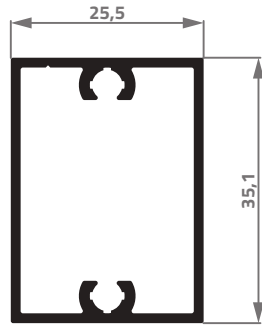

CG-012
0,501 Kg/m

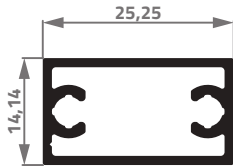

CG-021
0,321 Kg/m

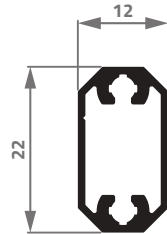

CG-022
0,238 Kg/m

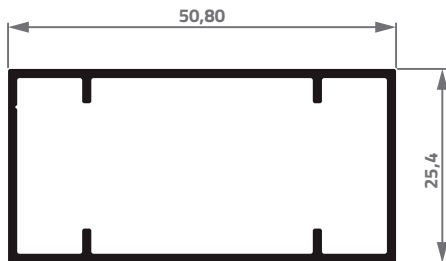

PC-002
0,520 Kg/m

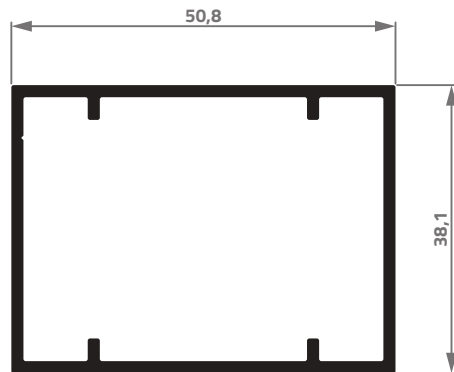

PC-004
0,795 Kg/m

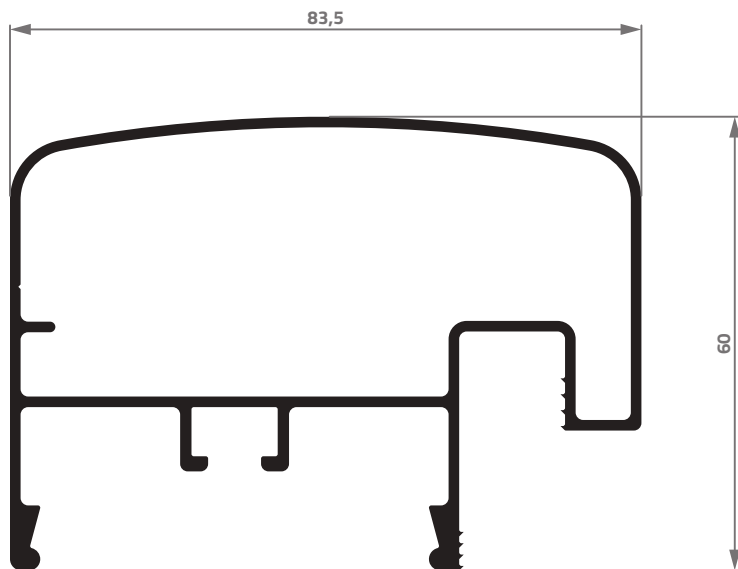

CG-083
1,324 Kg/m

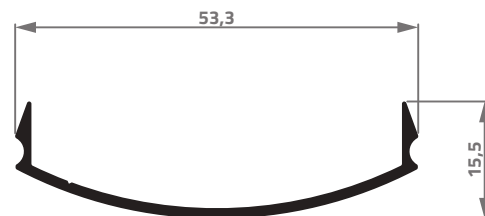

CG-074
0,268 Kg/m

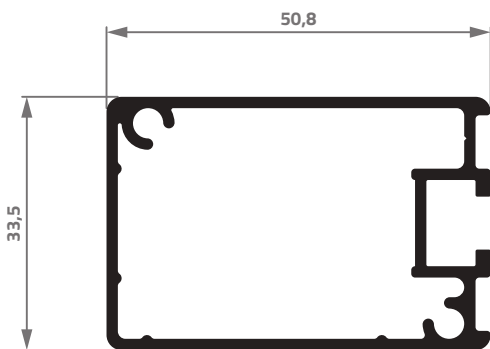

CG-077
0,840 Kg/m

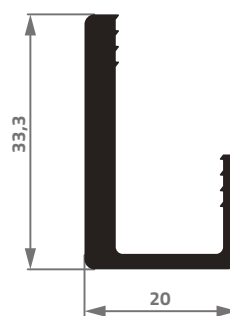

CG-075
0,520 Kg/m

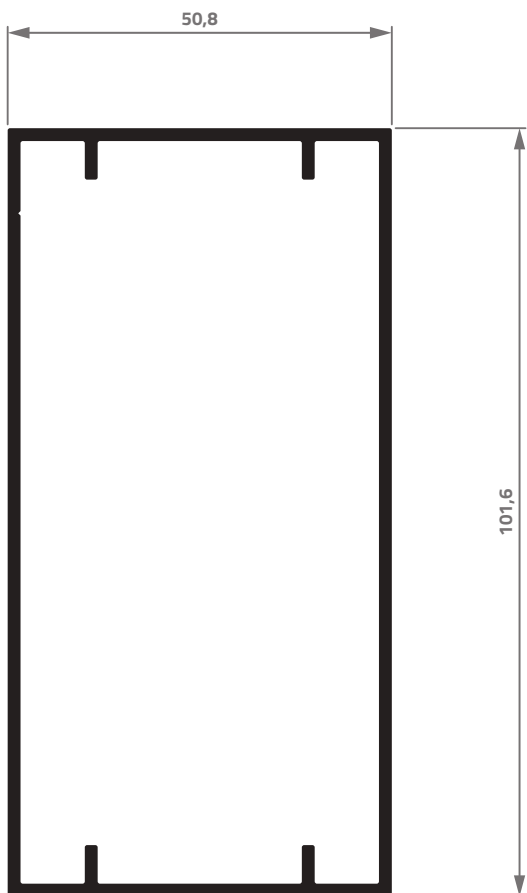

PC-072
1,467 Kg/m

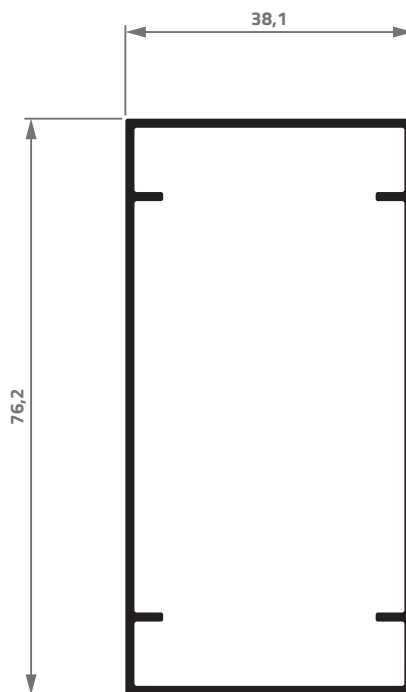

PC-003
0,777 Kg/m

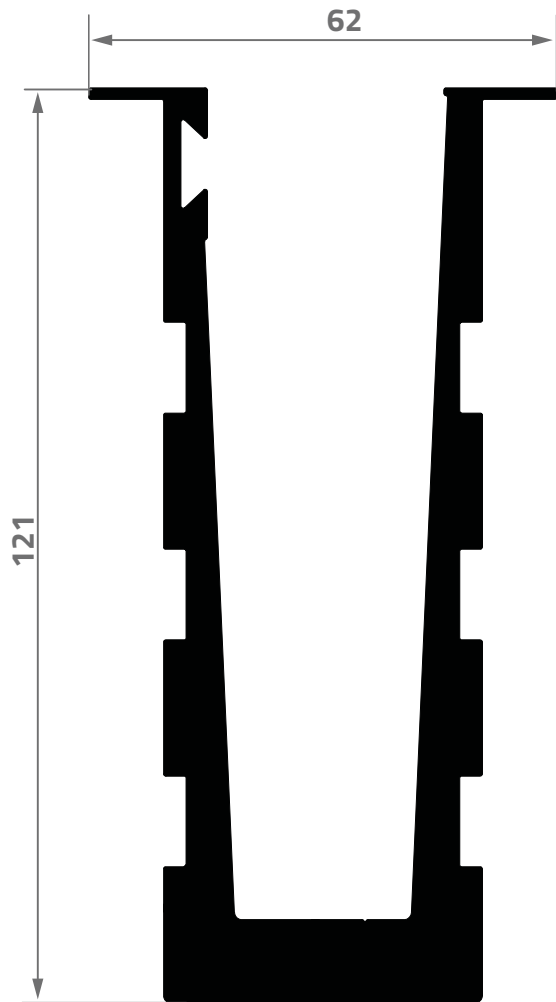

GR-U-02
4,883 Kg/m

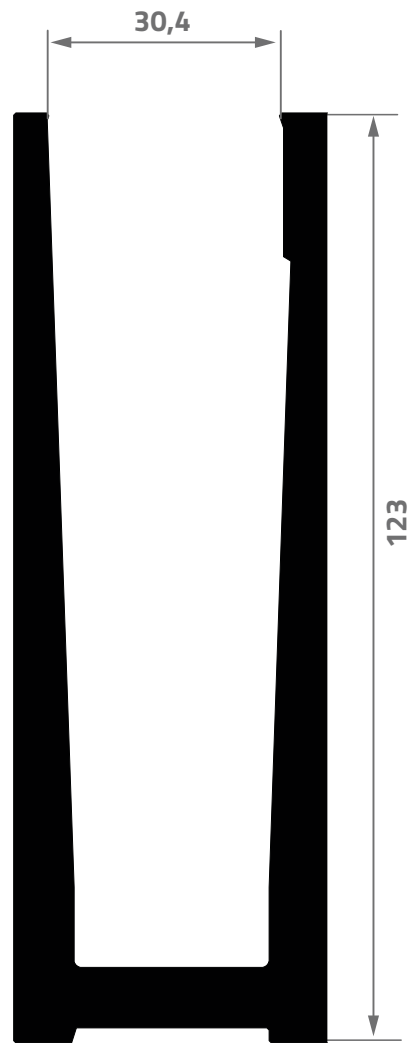

GR-U-01
4,972 Kg/m



ALUVIK G

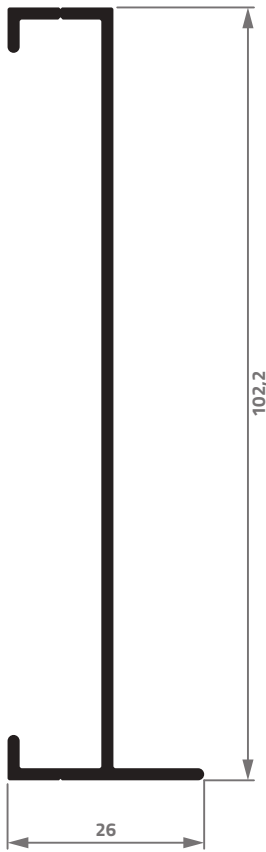

AG-002
0,639 Kg/m

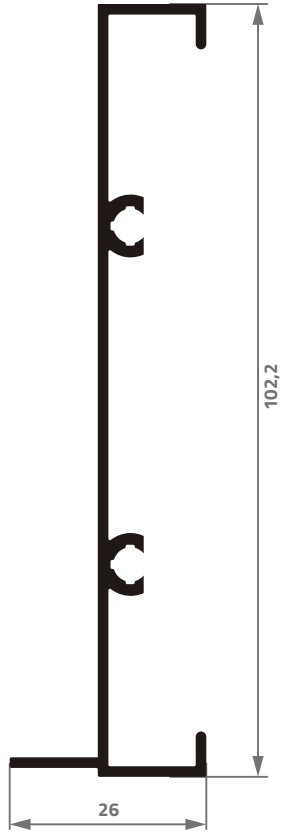

AG-003
0,756 Kg/m

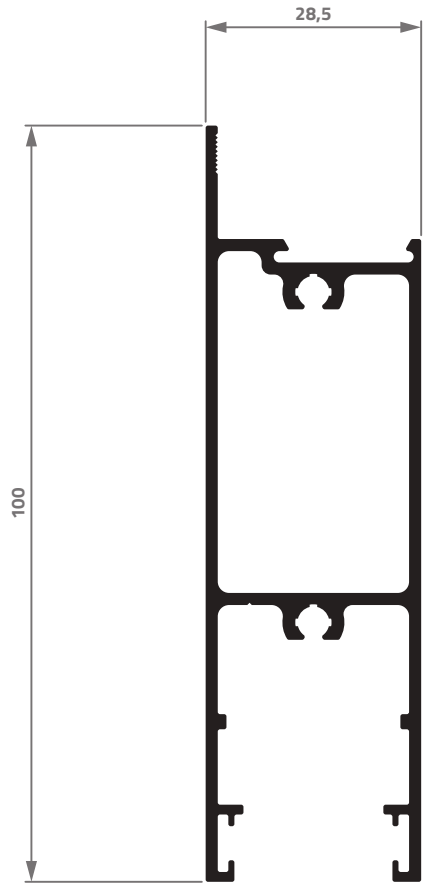

AG-007
1,229 Kg/m

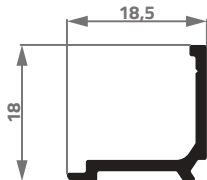

AG-015
0,147 Kg/m

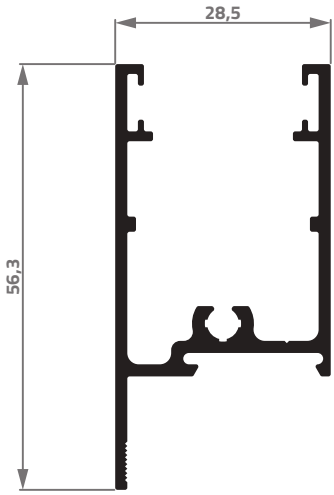

AG-006
0,675 Kg/m

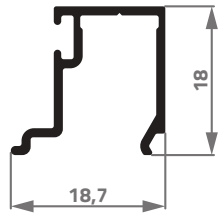

AG-057
0,167 Kg/m

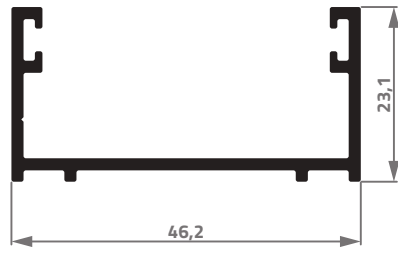

AG-028
0,455 Kg/m

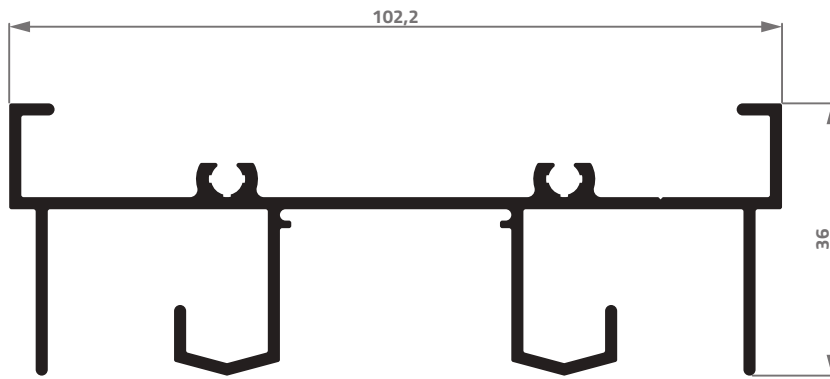

AG-044
1,244 Kg/m

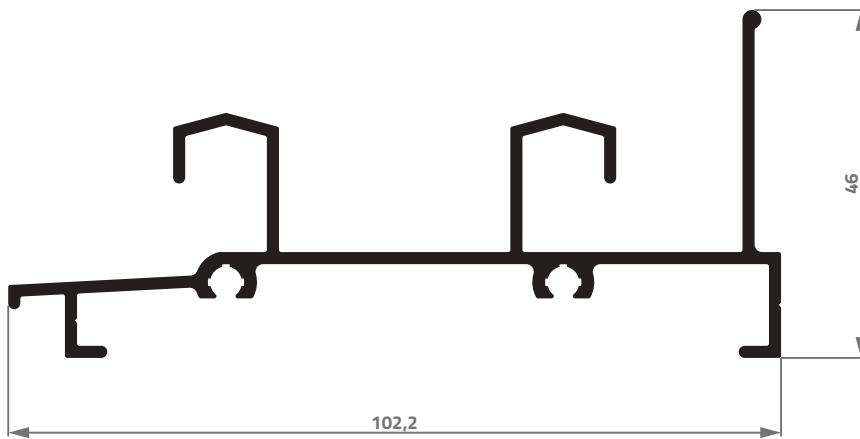

AG-047
1,133 Kg/m

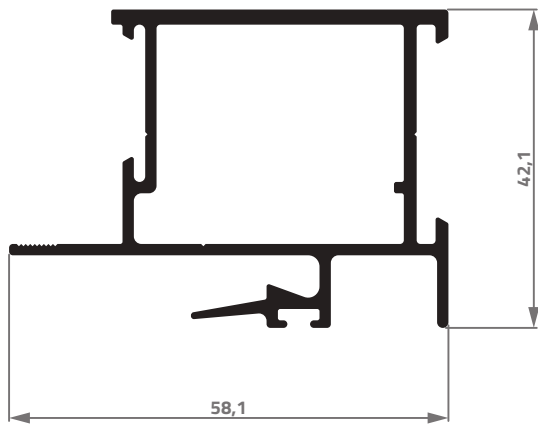

AG-048
0,973 Kg/m

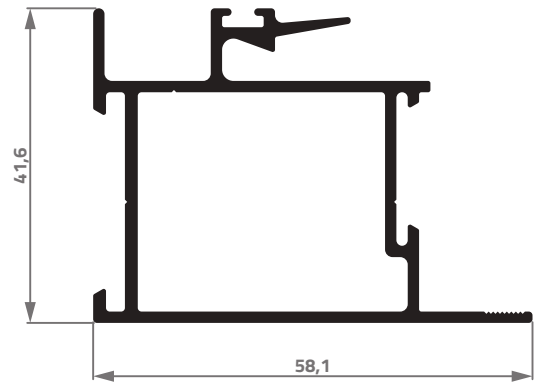

AG-049
0,905 Kg/m

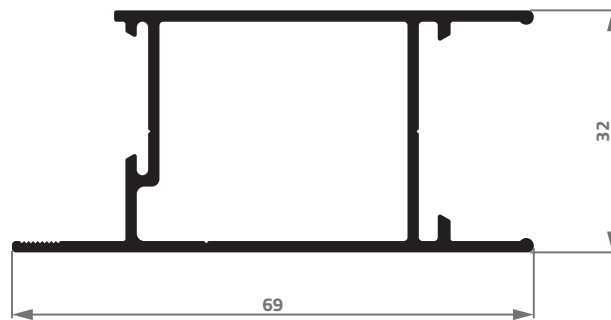

AG-050
0,817 Kg/m

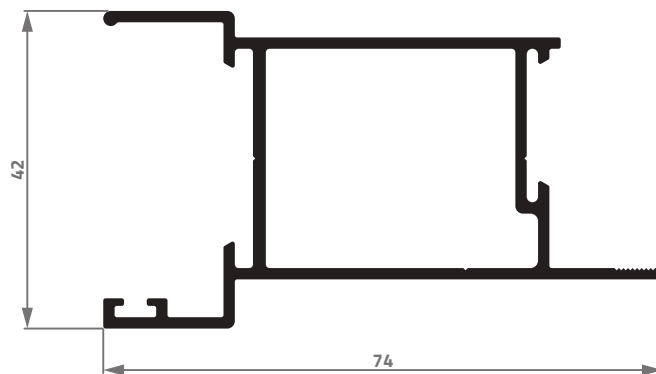

AG-051
0,916 Kg/m

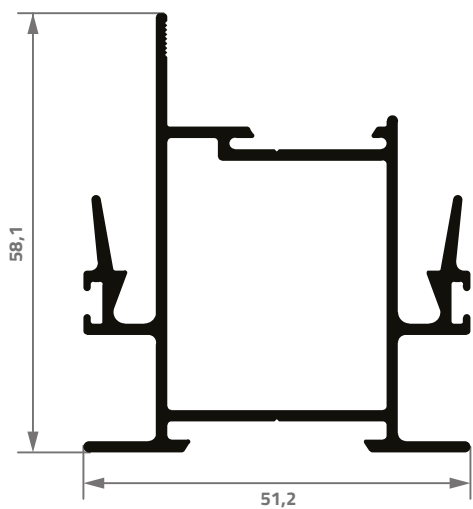

AG-162
1,075 Kg/m

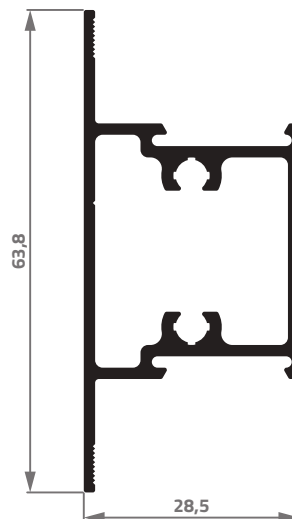

AG-055
0,756 Kg/m

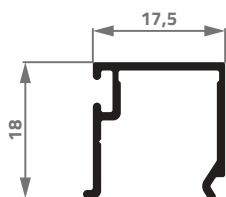

AG-059
0,168 Kg/m

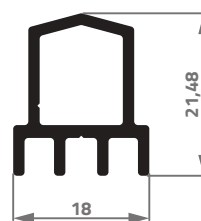

AG-061
0,320 Kg/m

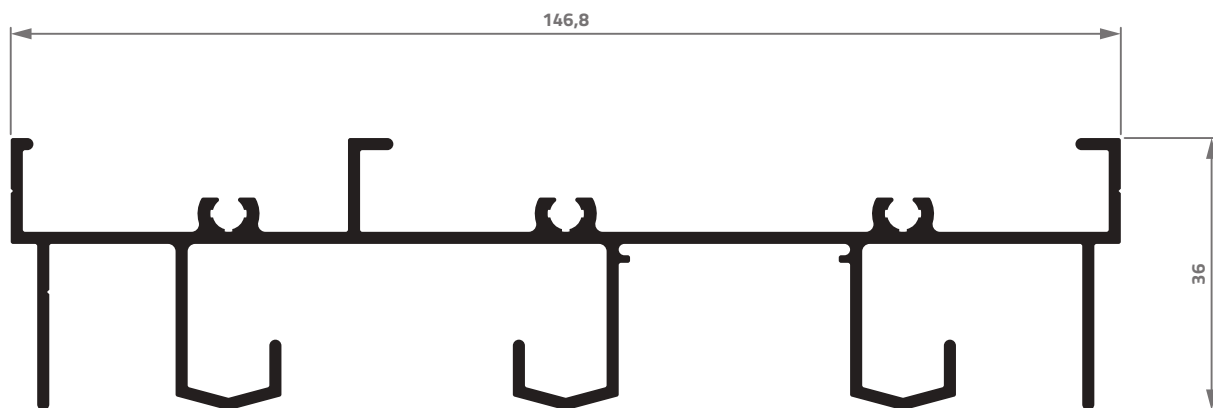

AG-062
1,729 Kg/m

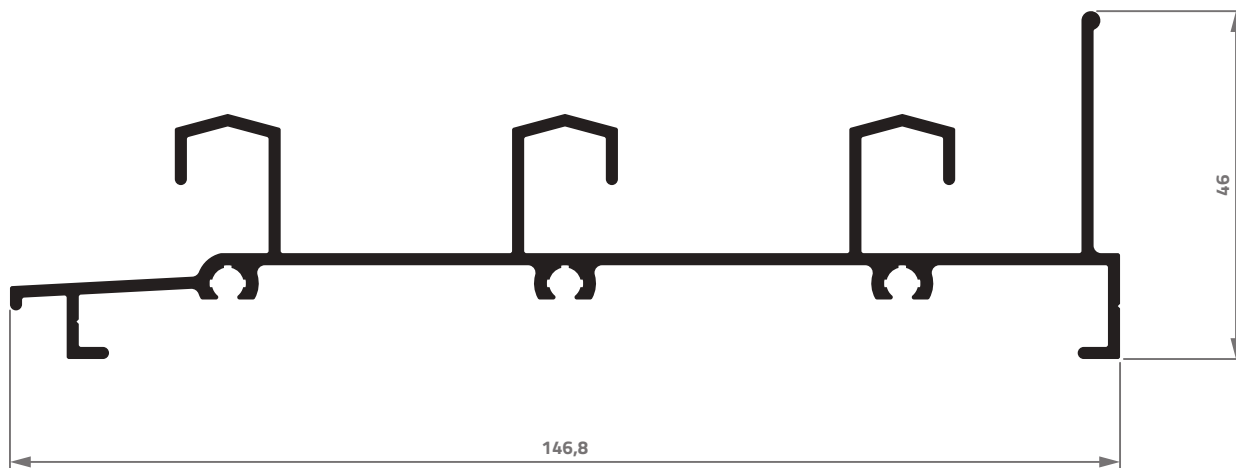

AG-066
1,539 Kg/m

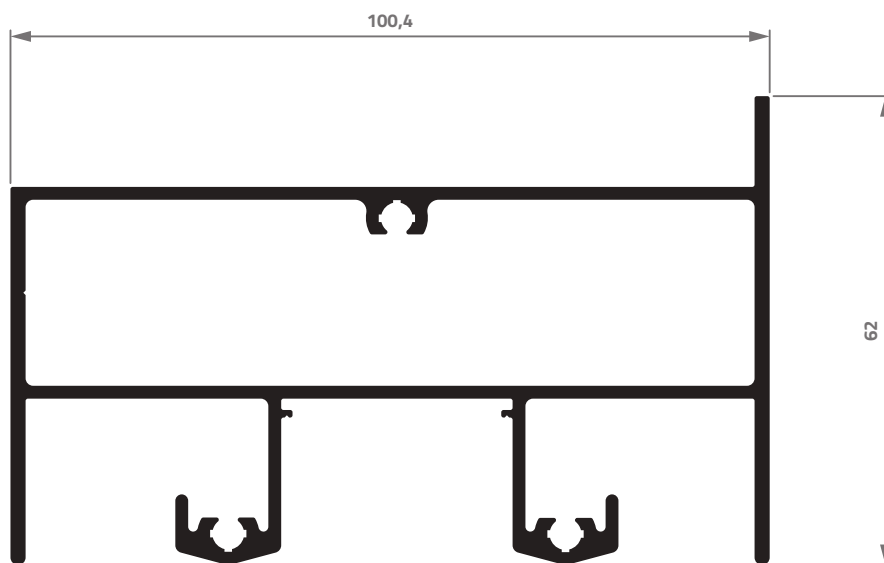

AG-004
2,035 Kg/m

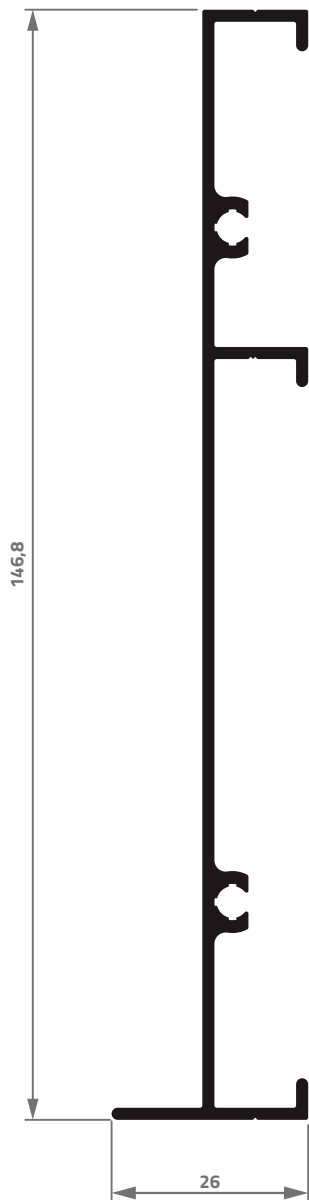

AG-3158
1,014 Kg/m

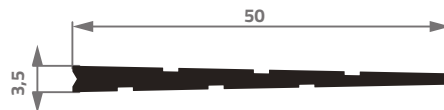

CL-011
0,317 Kg/m

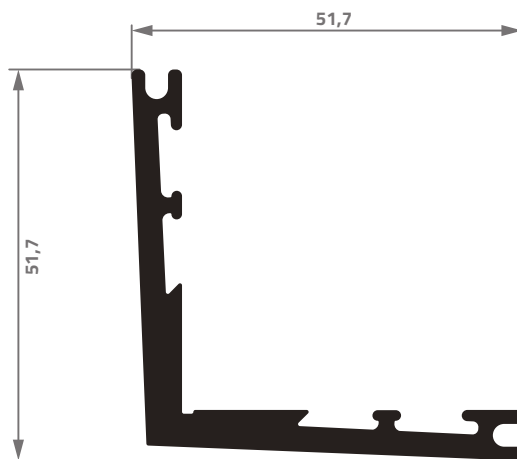

CL-006
1,108 Kg/m

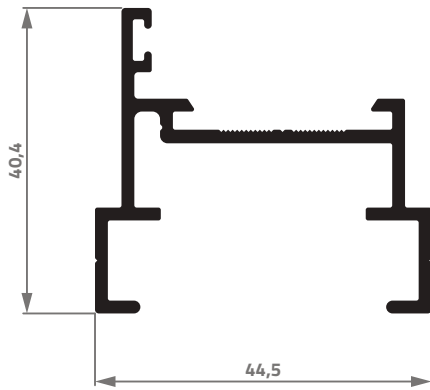

AG-056
0,642 Kg/m

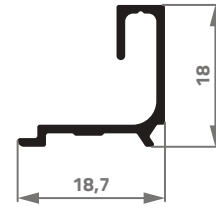

AG-027
0,149 Kg/m

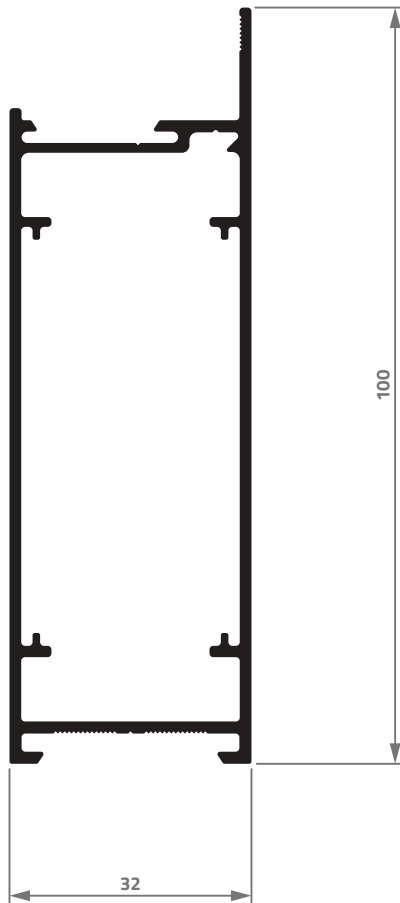

AG-042
1,154 Kg/m

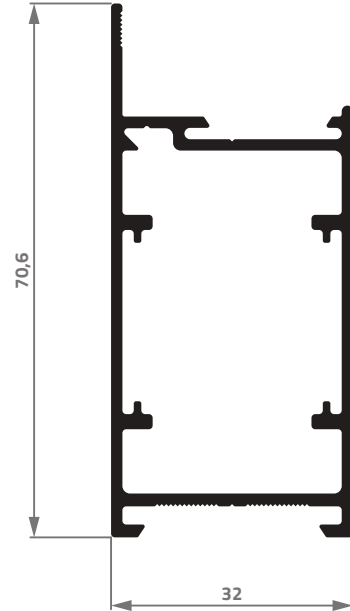

AG-043
0,935 Kg/m

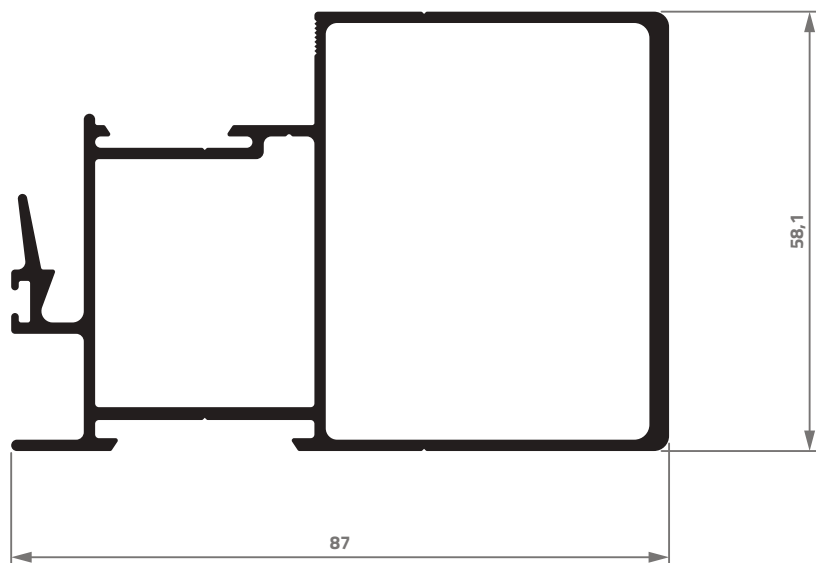

AG-052
1,667 Kg/m

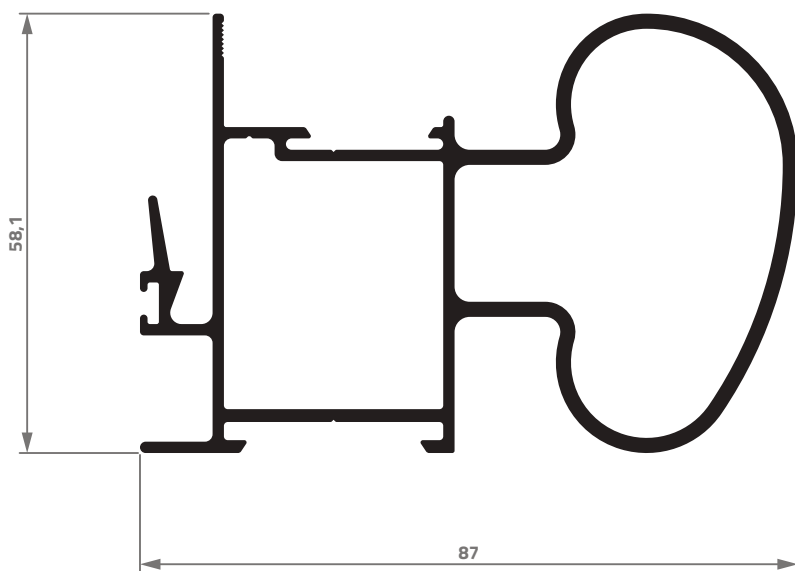

AG-021
1,734 Kg/m

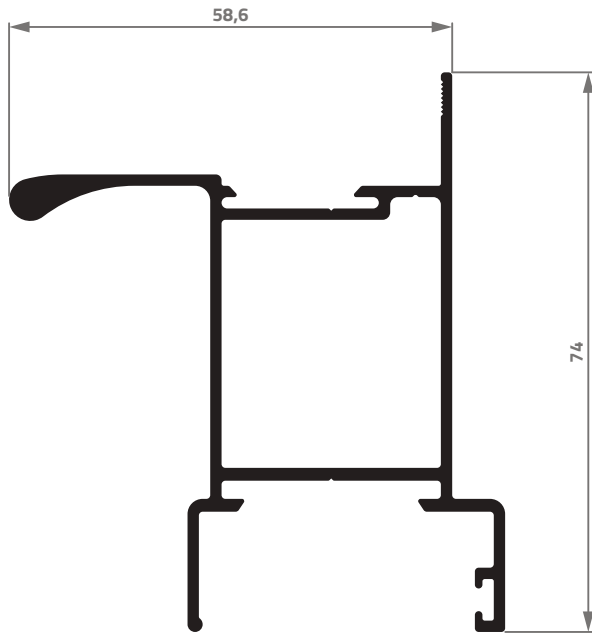

AG-020
1,116 Kg/m

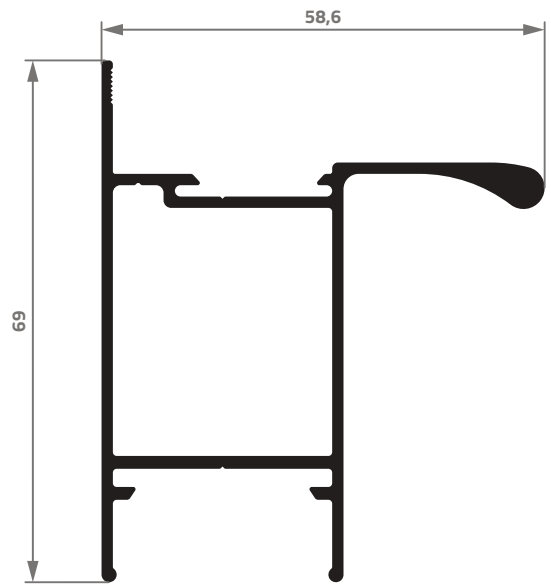

AG-017
1,009 Kg/m

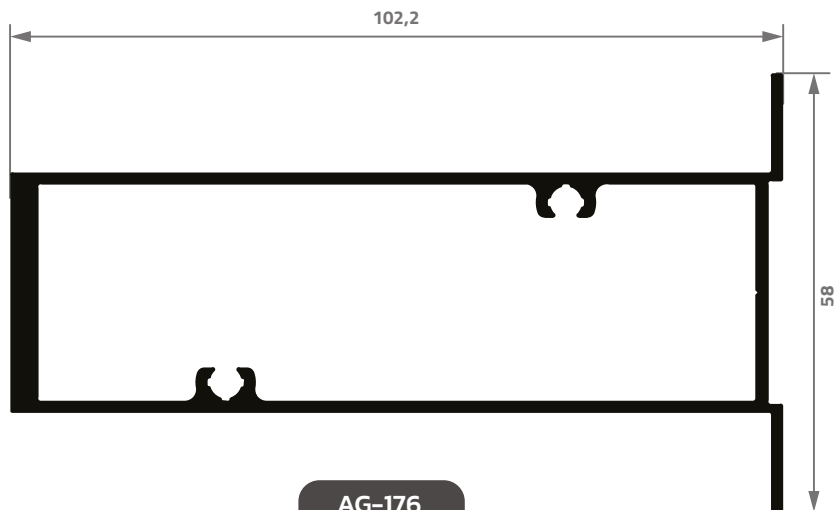

AG-176
1,531 Kg/m

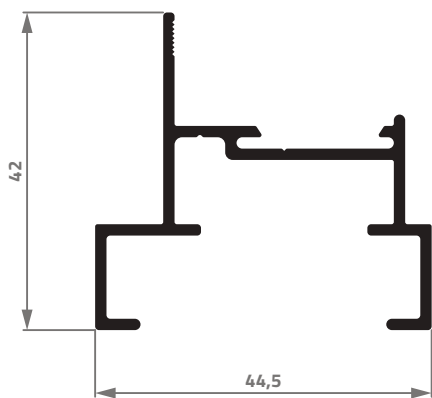

AG-063
0,549 Kg/m

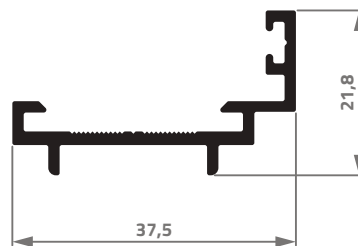

AG-016
0,332 Kg/m

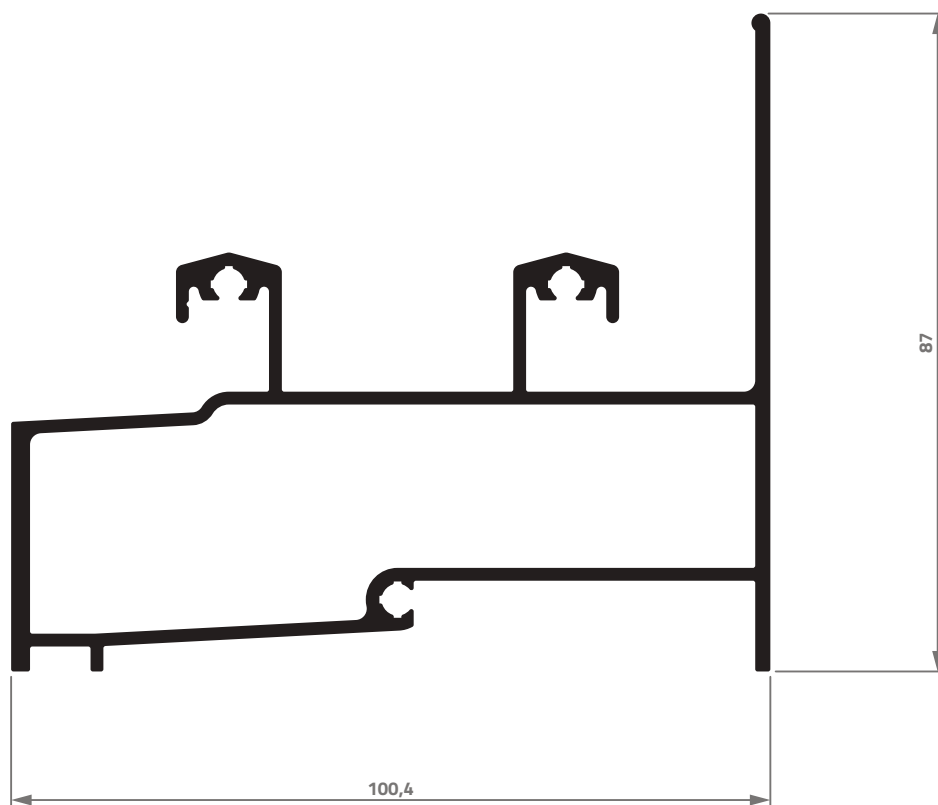

AG-005
2,103 Kg/m

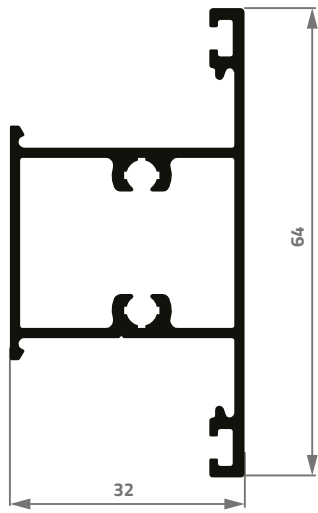

AG-074
0,791 Kg/m

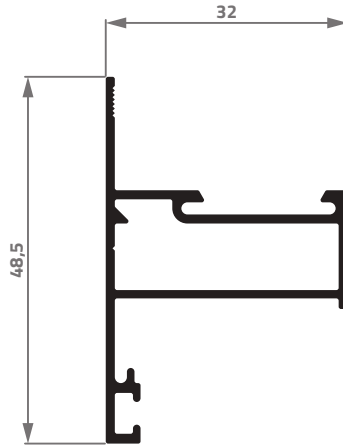

AG-085
0,466 Kg/m

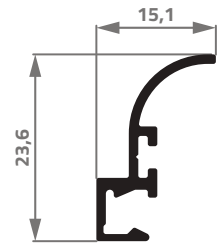

AG-091
0,160 Kg/m

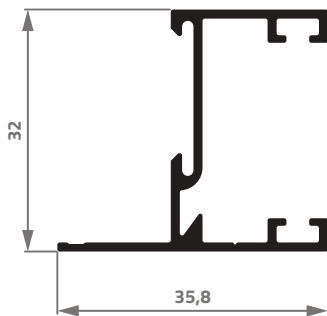

AG-083
0,385 Kg/m

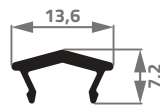

AG-111
0,081 Kg/m

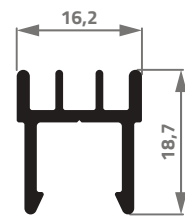

AG-157
0,253 Kg/m

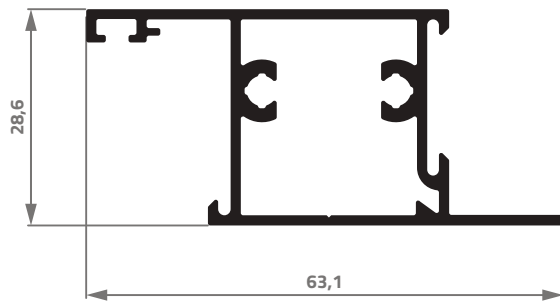

AG-076
0,759 Kg/m

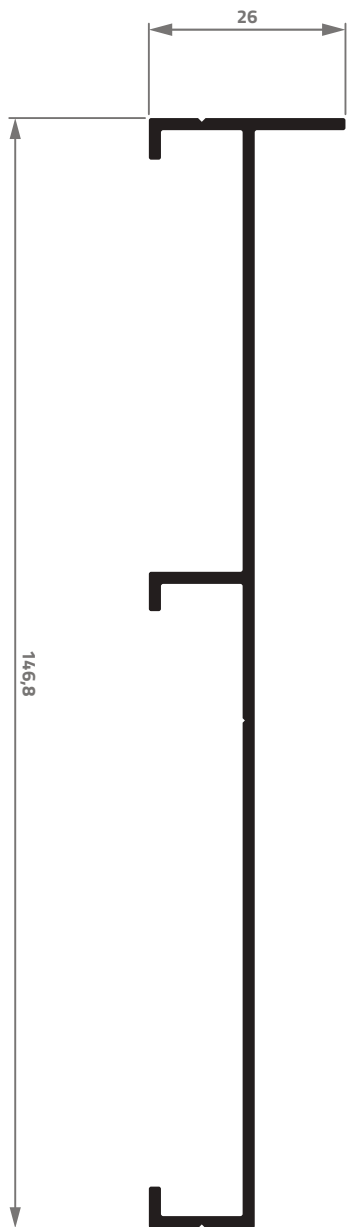

AG-158
0,897 Kg/m

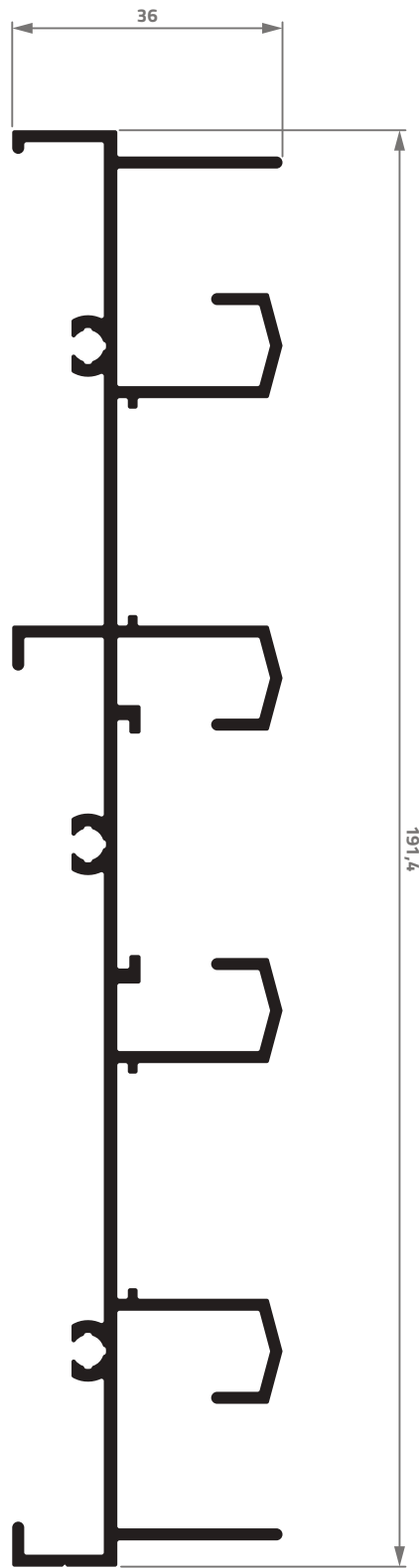

AG-070
2,222 Kg/m

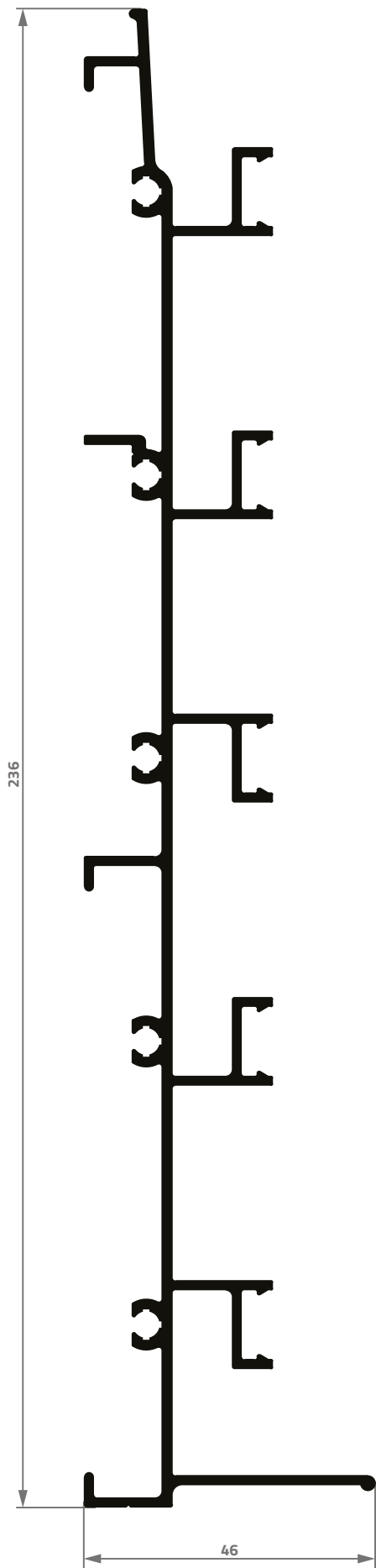

AG-600
2,562 Kg/m

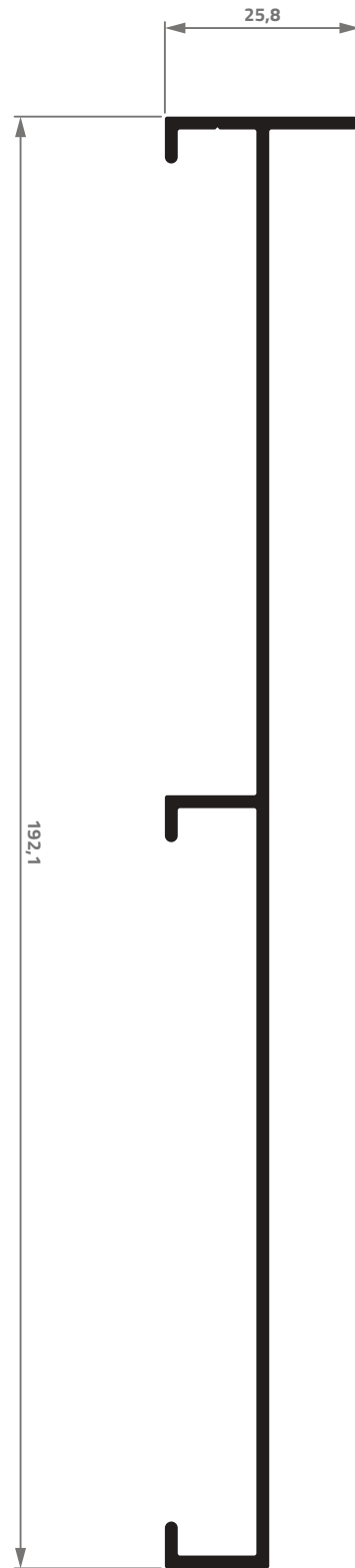

AG-072
1,166 Kg/m

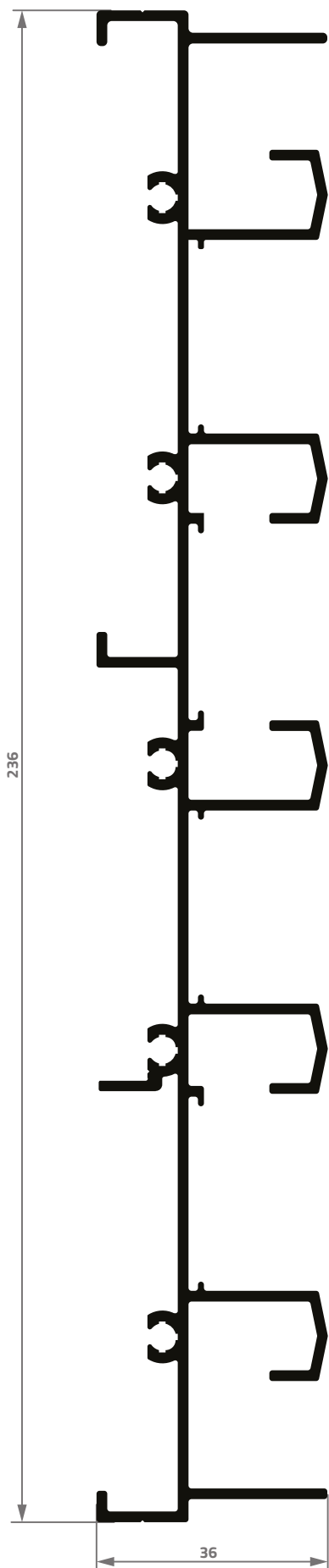

AG-601
2,769 Kg/m

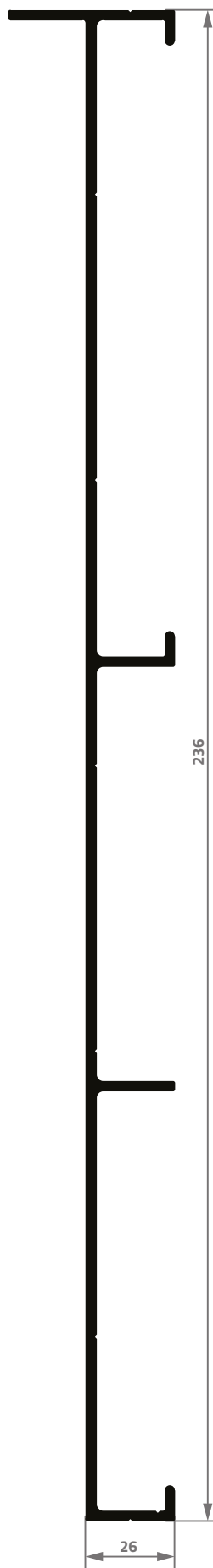

AG-602
1,466 Kg/m

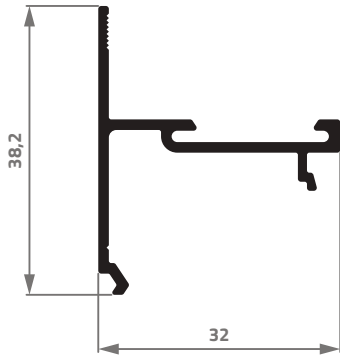

AG-077
0,327 Kg/m

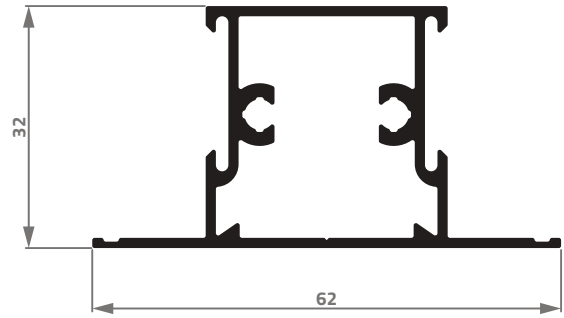

AG-079
0,756 Kg/m

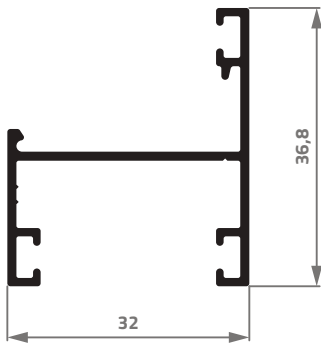

AG-068
0,369 Kg/m

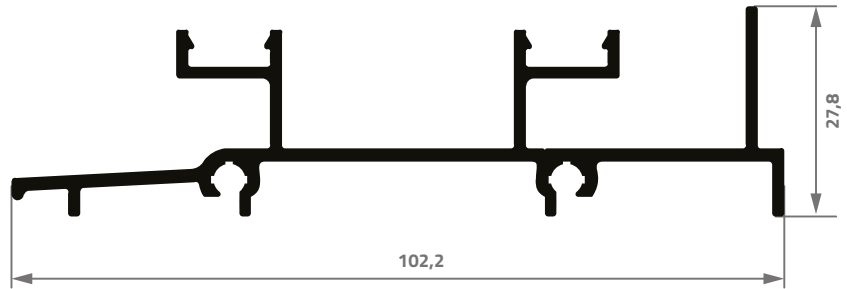

AG-125
1,008 Kg/m

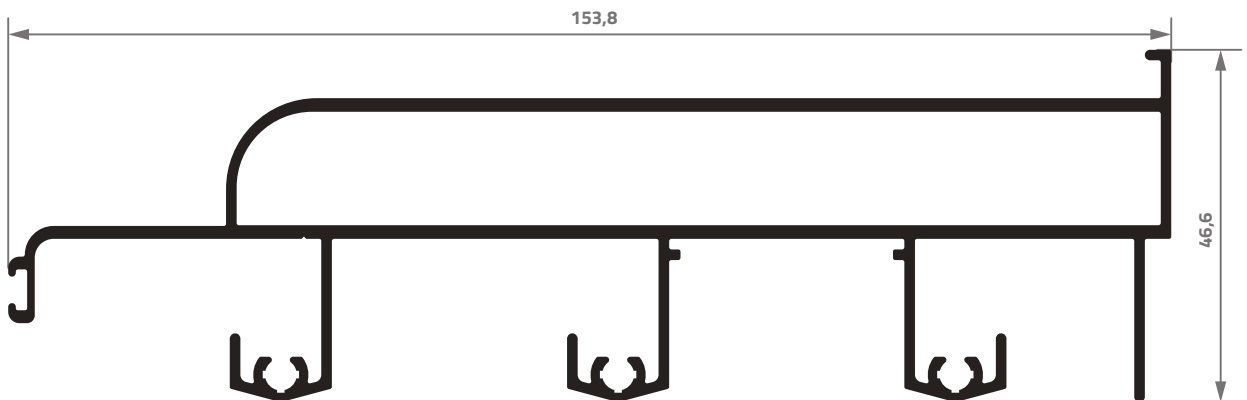

AG-034
2,149 Kg/m

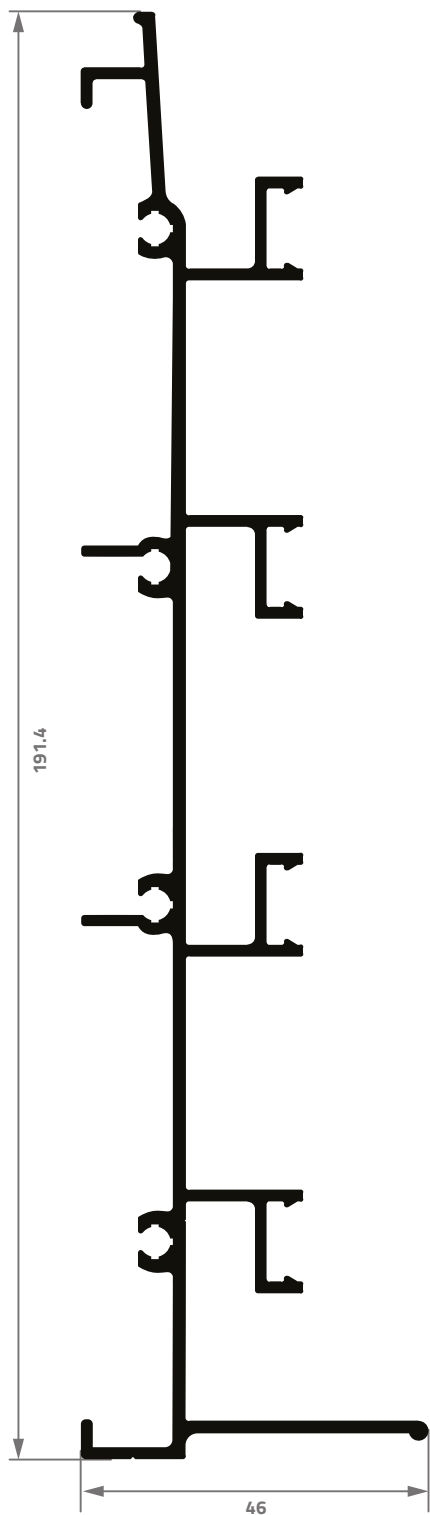

AG-160
2,085 Kg/m

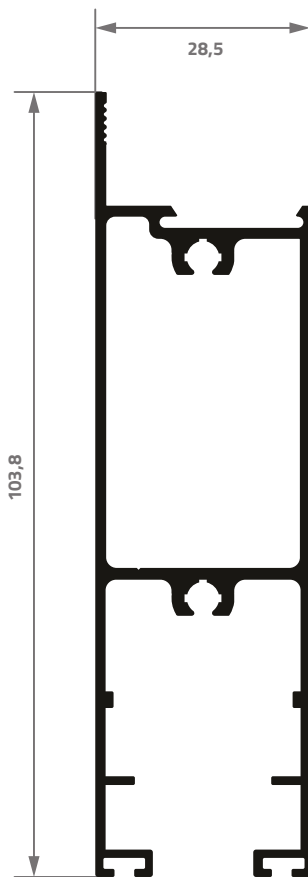

AG-640
1,277 Kg/m

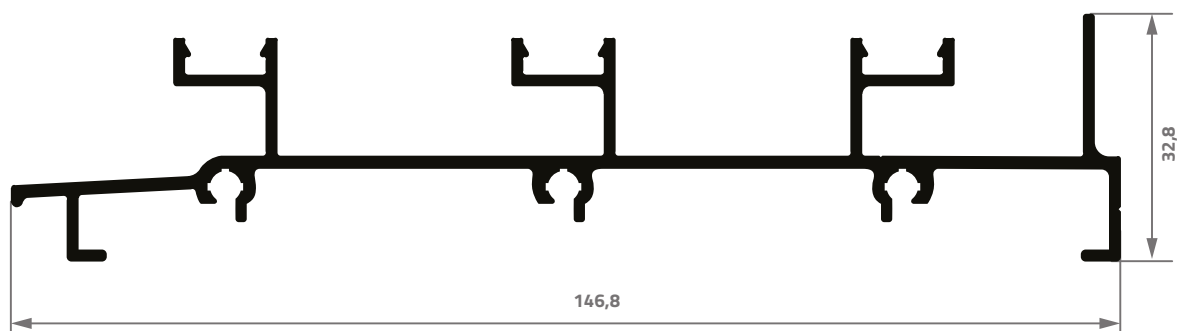

AG-143
1,499 Kg/m

The image features a white background with abstract geometric elements. In the top-left and bottom-right corners, there are clusters of red and black triangles. A red bar is positioned at the top right, and another red bar is at the bottom left. A prominent red rounded rectangle is centered horizontally, containing the text 'ALUVIK S' in white, uppercase, sans-serif font.

ALUVIK S

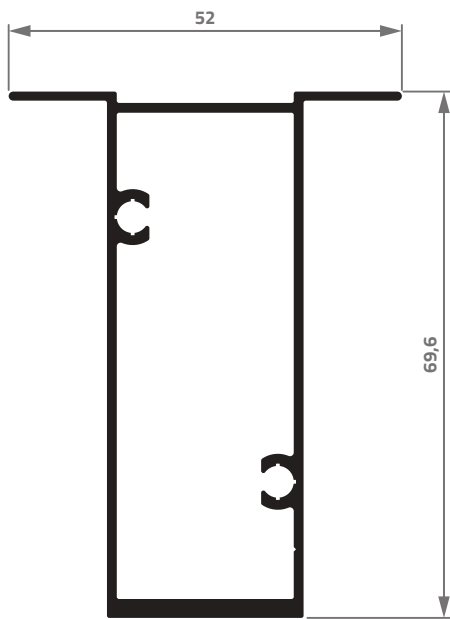

AS-009
0,896 Kg/m

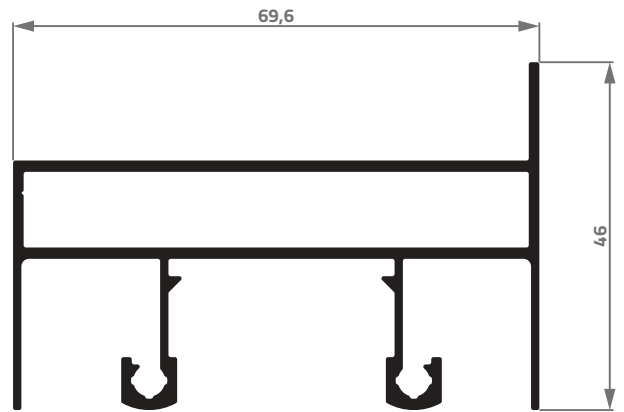

AS-005
1,092 Kg/m

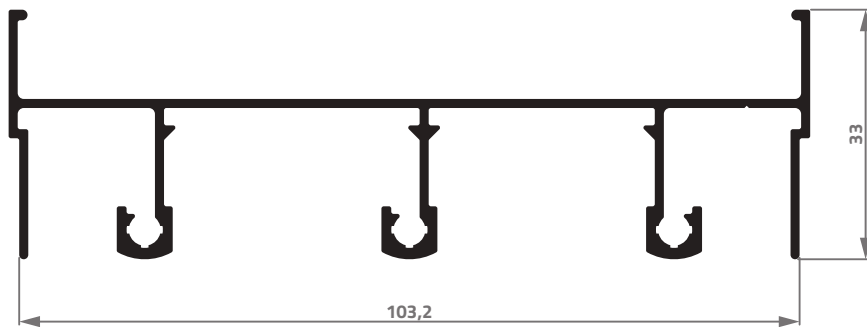

AS-010
0,970 Kg/m

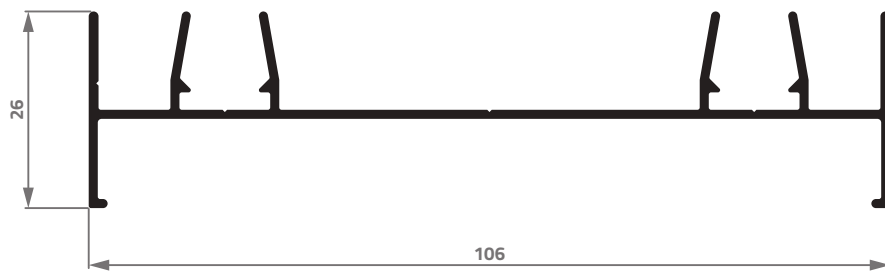

AS-013
0,707 Kg/m

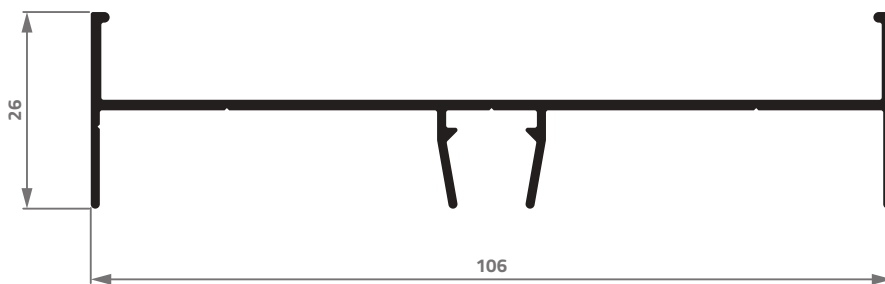

AS-014
0,676 Kg/m

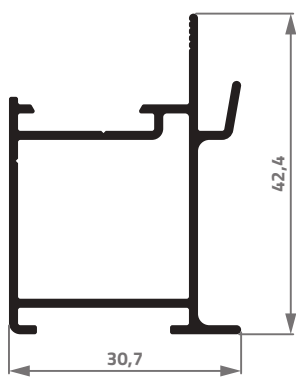

AS-040
0,476 Kg/m

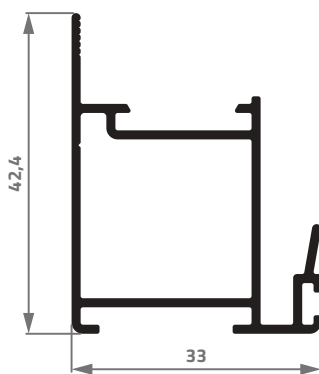

AS-041
0,506 Kg/m

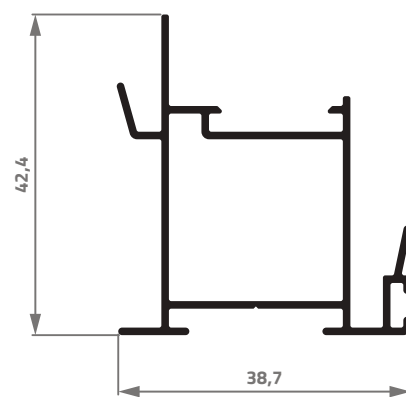

AS-042
0,474 Kg/m

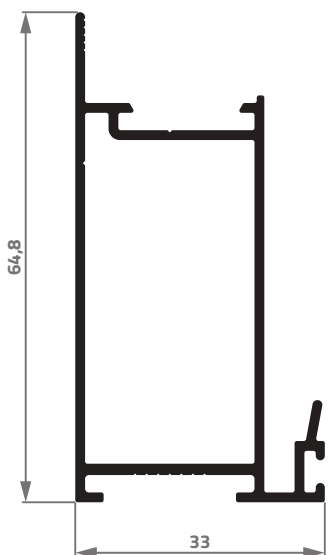

AS-242
0,712 Kg/m

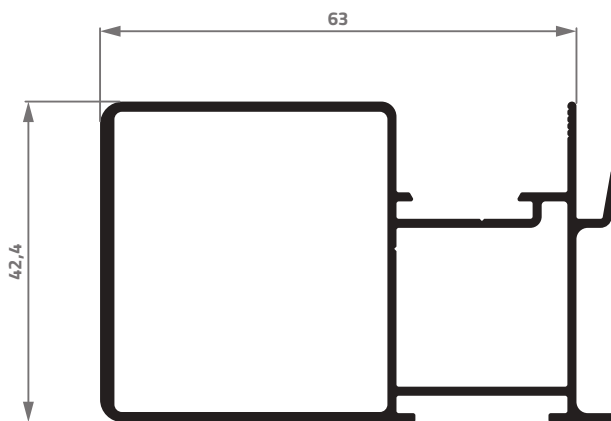

AS-047
1,046 Kg/m

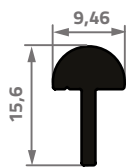

G-021
0,166 Kg/m

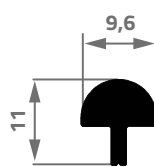

DES-259
0,155 Kg/m

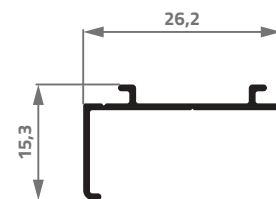

AS-084
0,114 Kg/m

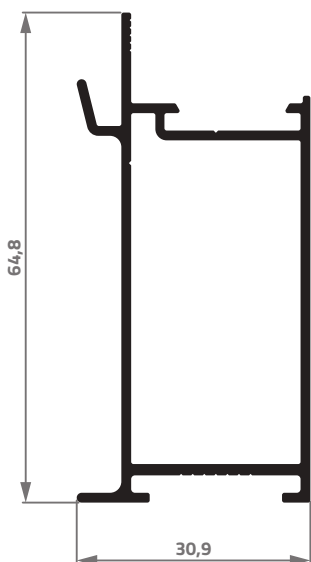

AS-243
0,686 Kg/m

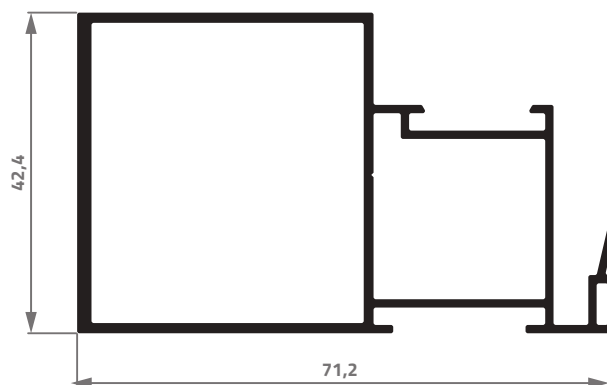

AS-049
0,969 Kg/m

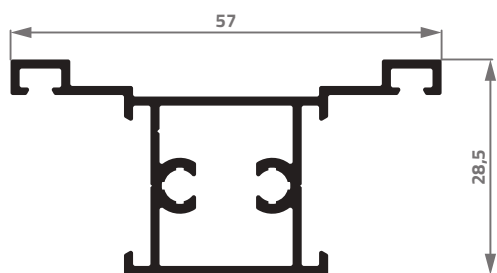

AS-086
0,586 Kg/m

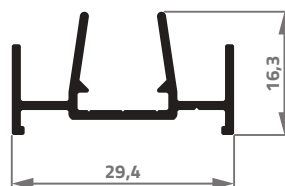

AS-291
0,263 Kg/m

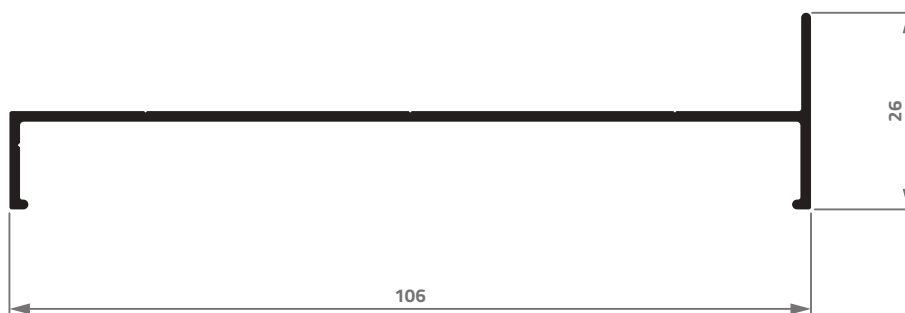

AS-012
0,542 Kg/m

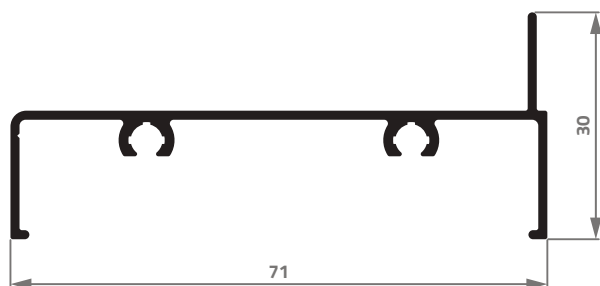

AS-004
0,479 Kg/m

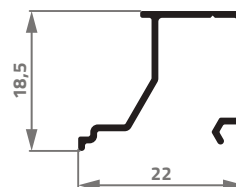

AS-103
0,141 Kg/m

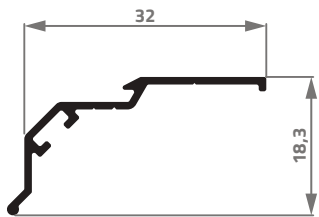

AS-083
0,143 Kg/m

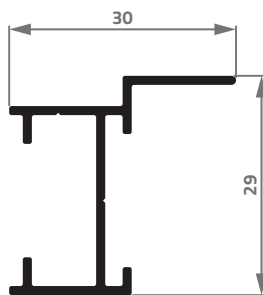

AS-071
0,277 Kg/m

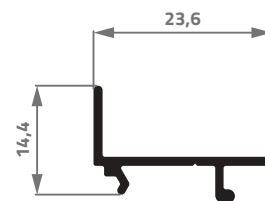

AS-108
0,144 Kg/m

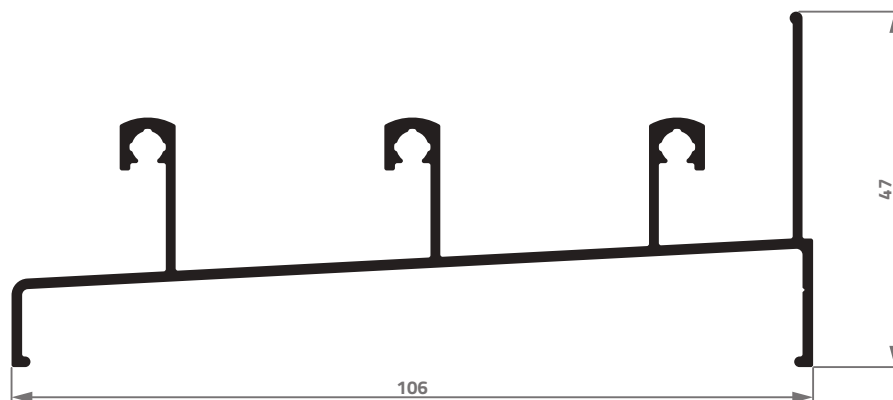

AS-011
0,967 Kg/m

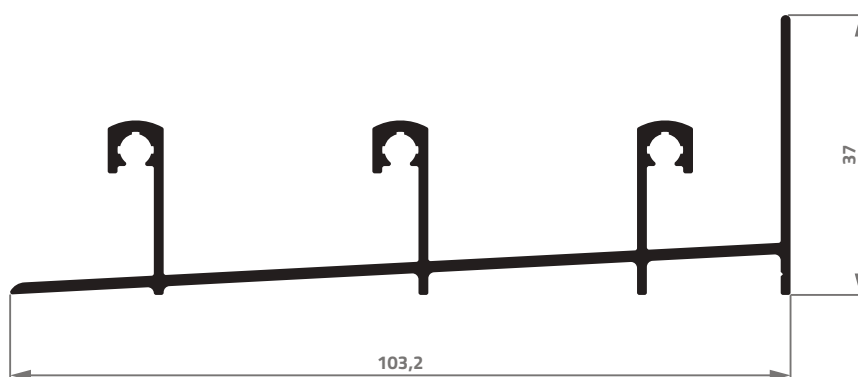

AS-230
0,932 Kg/m

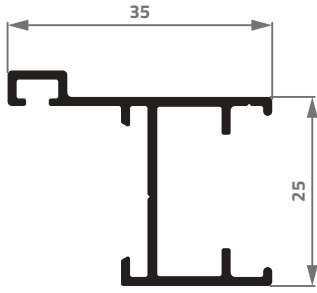

AS-079
0,341 Kg/m

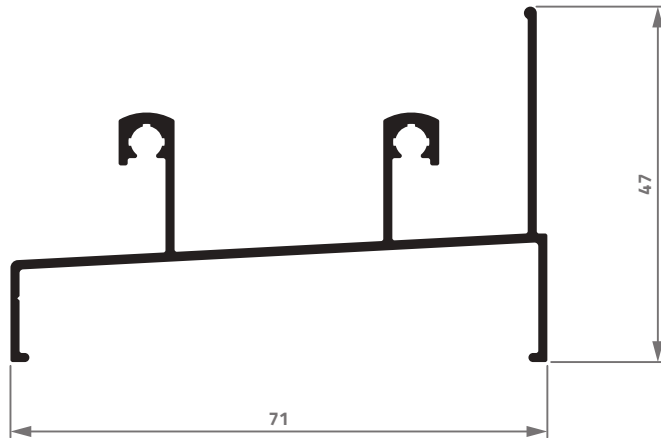

AS-002
0,650 Kg/m

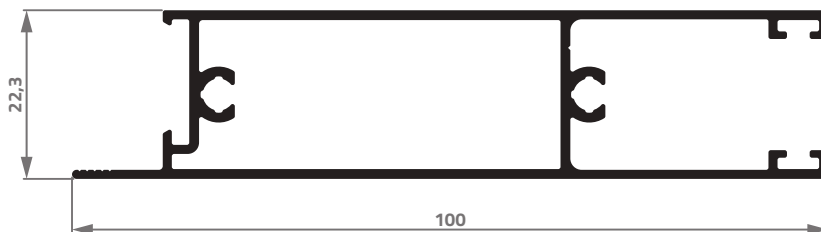

AS-225
0,935 Kg/m

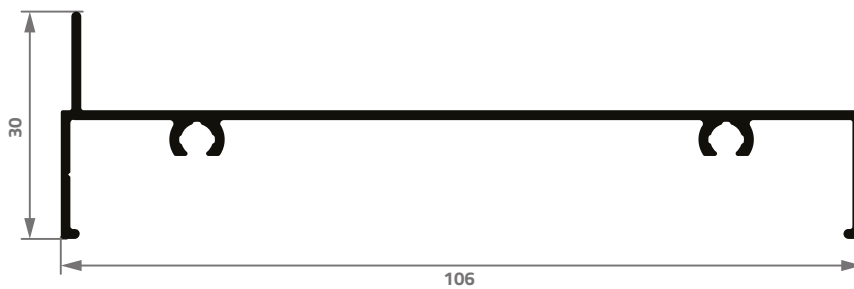

AS-018
0,630 Kg/m

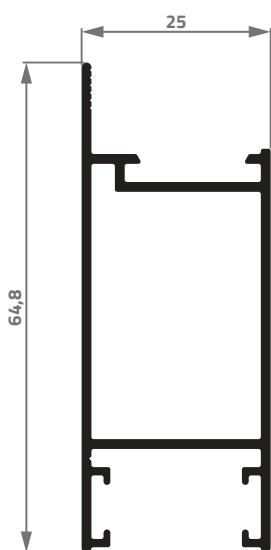

AS-245
0,639 Kg/m

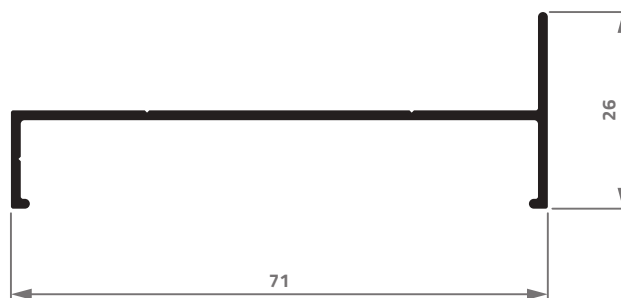

AS-007
0,385 Kg/m

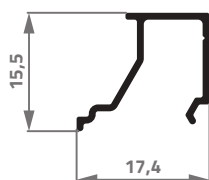

AS-102
0,110 Kg/m

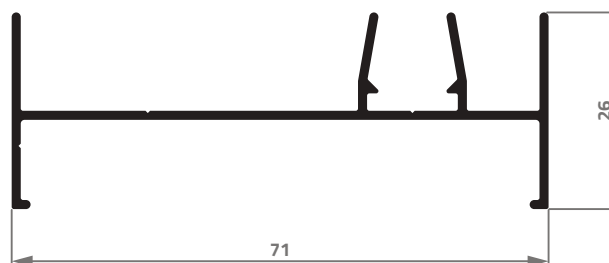

AS-003
0,490 Kg/m

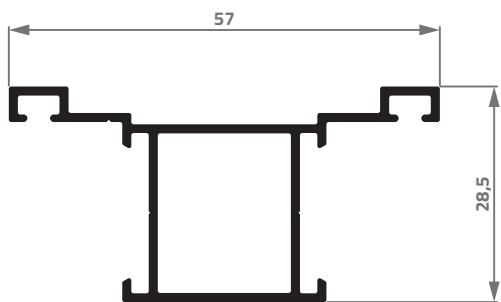

AS-085
0,501 Kg/m

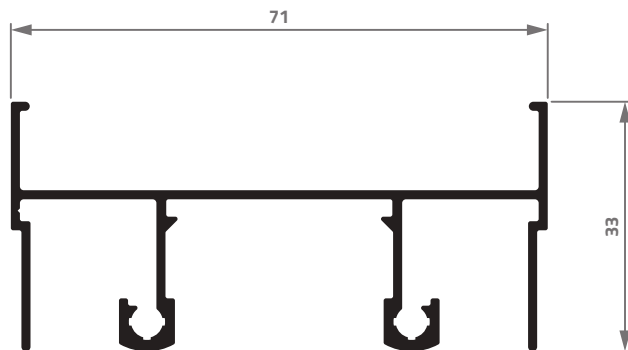

AS-001
0,713 Kg/m

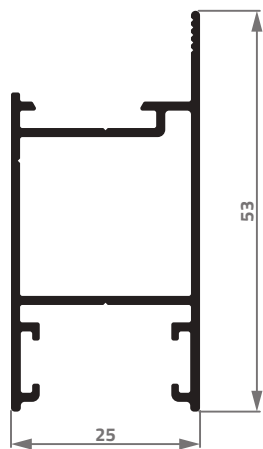

AS-039
0,526 Kg/m

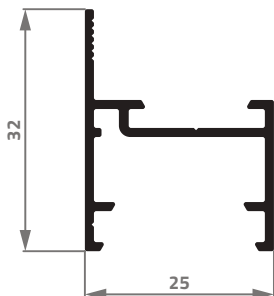

AS-088
0,292 Kg/m

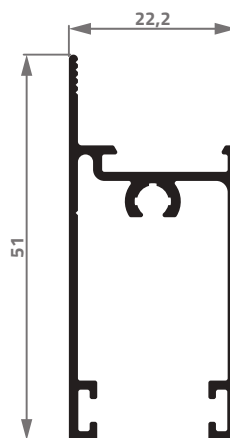

AS-053
0,472 Kg/m

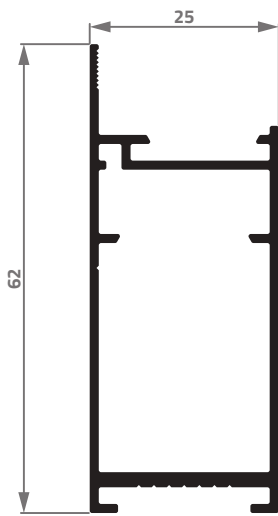

AS-111
0,621 Kg/m

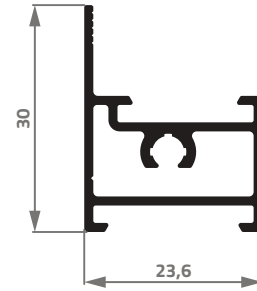

AS-082
0,382 Kg/m

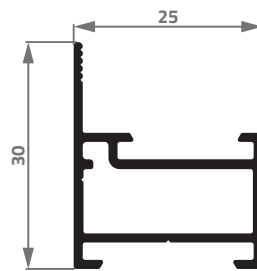

AS-080
0,355 Kg/m

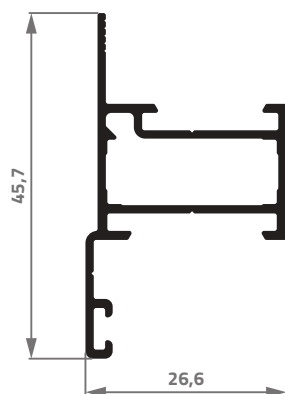

AS-200
0,409 Kg/m

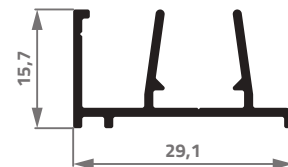

AS-008
0,247 Kg/m

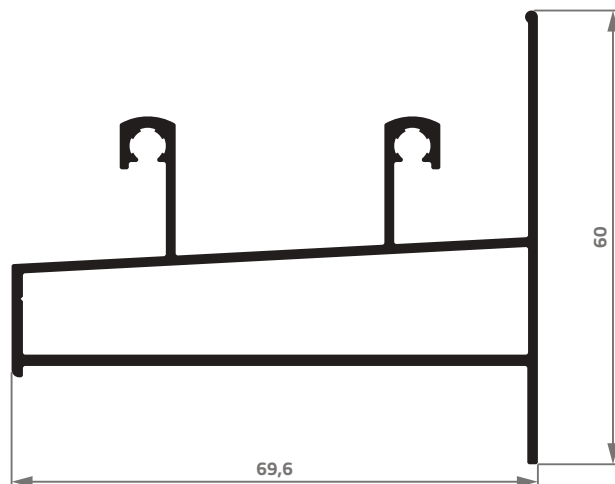

AS-006
1,025 Kg/m

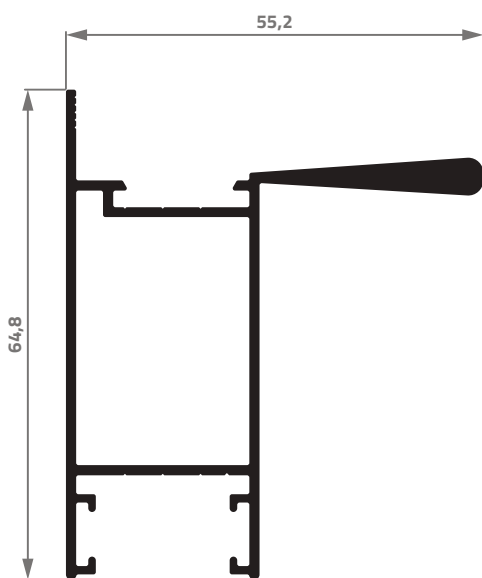

AS-280
0,915 Kg/m

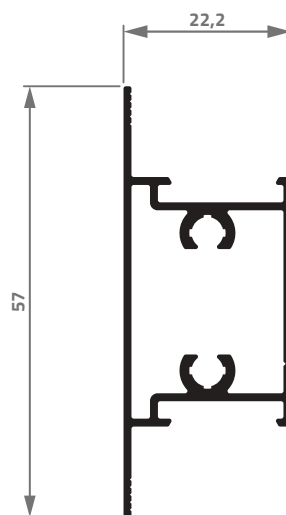

AS-227
0,505 Kg/m

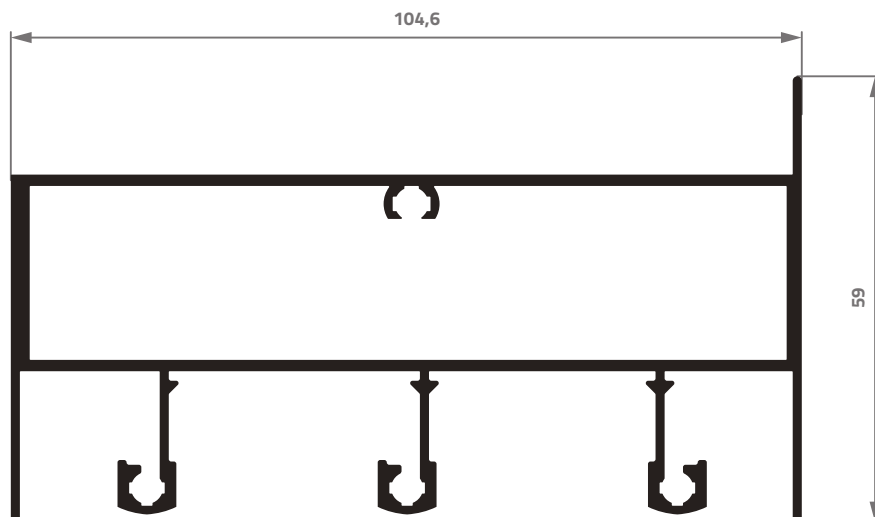

AS-019
1,748 Kg/m

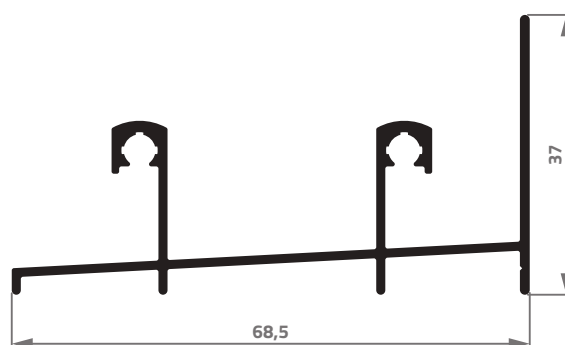

AS-228
0,609 Kg/m

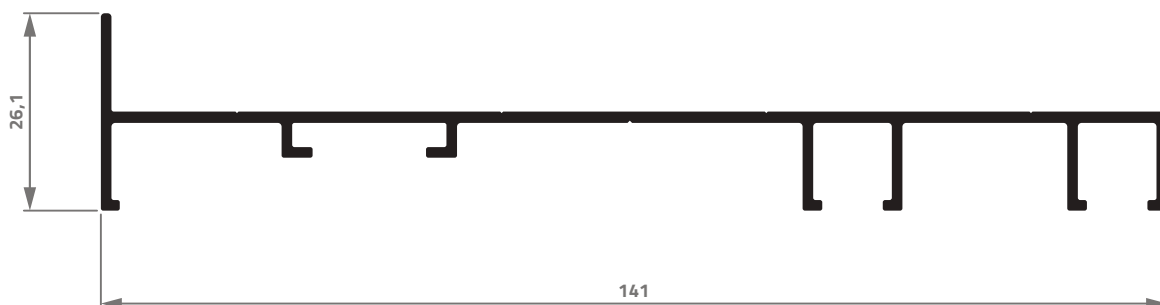

AS-123
0,920 Kg/m

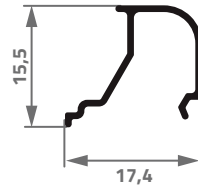

AS-104
0,101 Kg/m

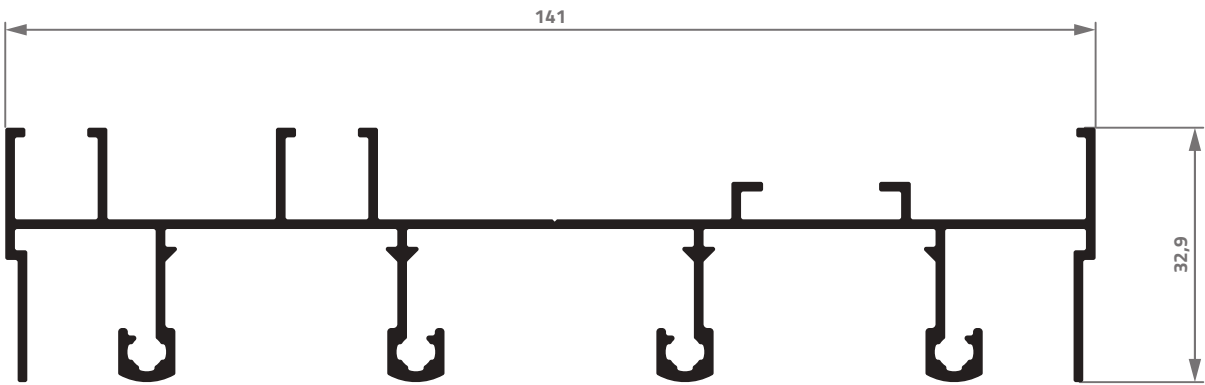

AS-121
1,415 Kg/m

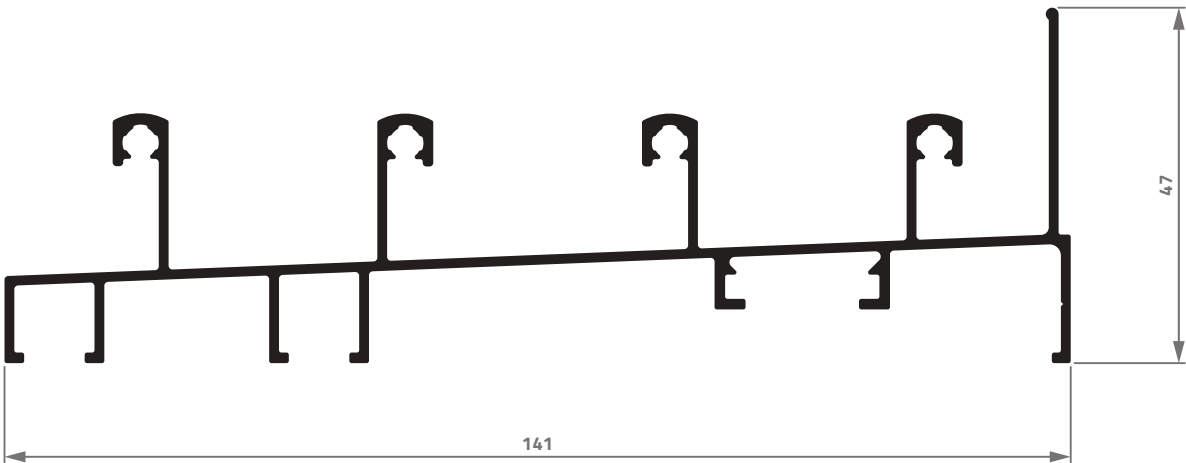

AS-122
1,407 Kg/m



LAMBRIS

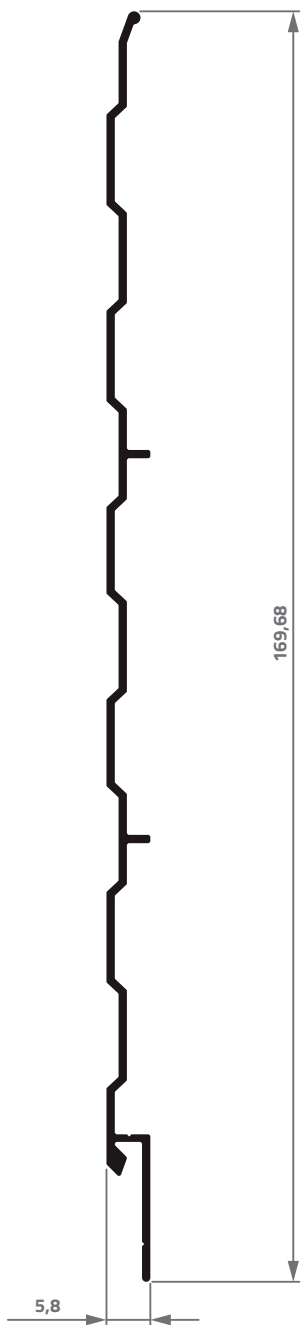

LB-001
0,626 Kg/m

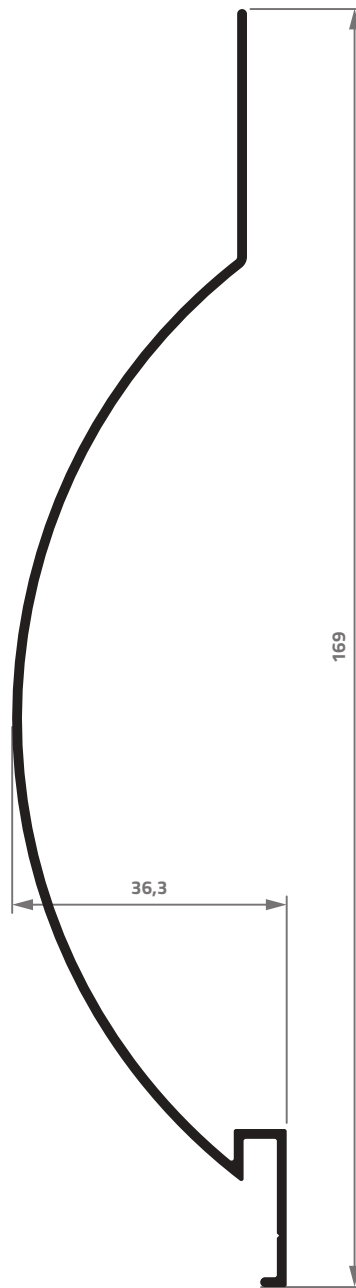

LB-002G
0,726 Kg/m

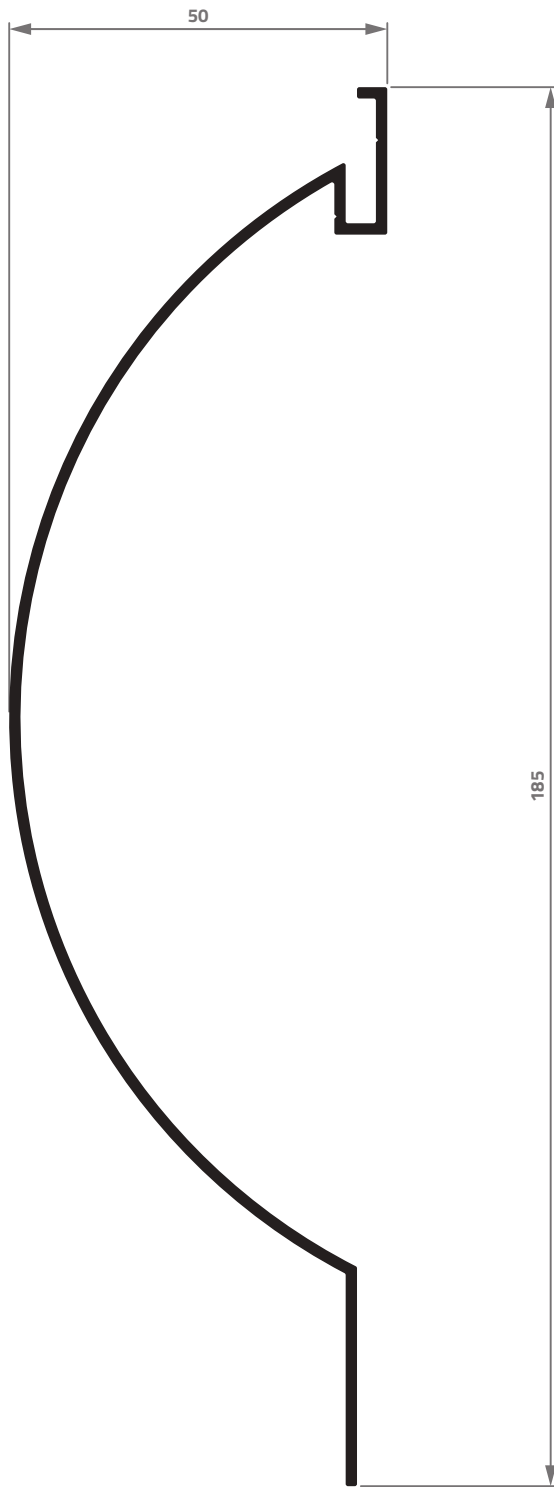

LB-038
0,973 Kg/m



LB-600G
1,072 Kg/m

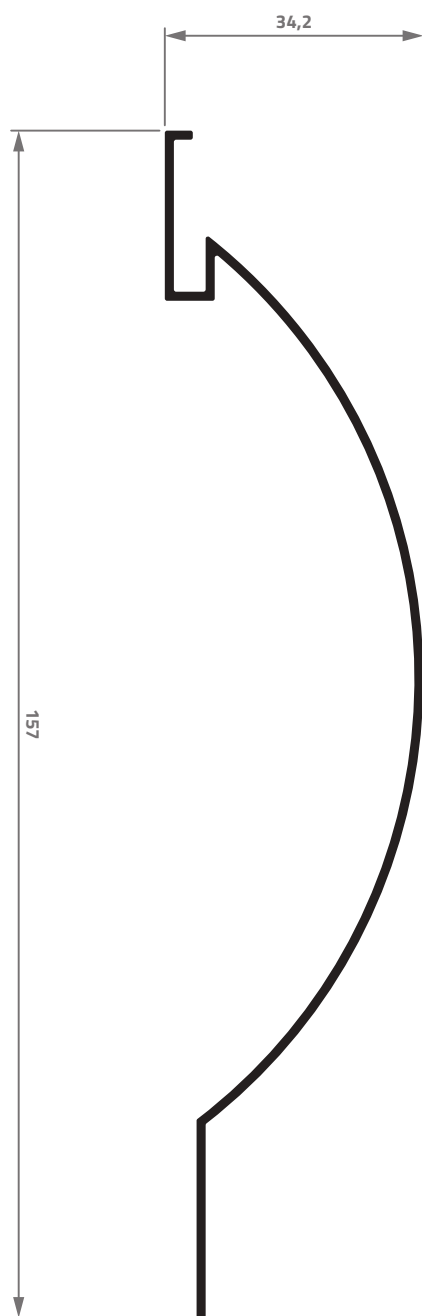

LB-002
0,638 Kg/m



LB-600
0,669 Kg/m

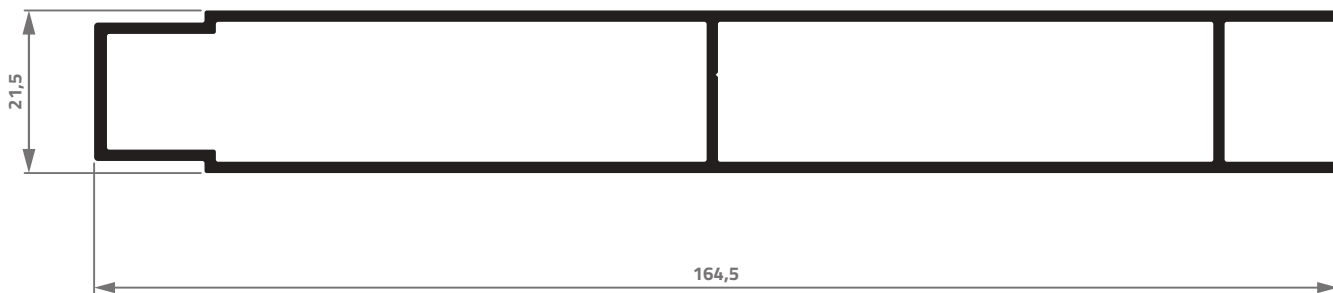

LB-080
1,570 Kg/m

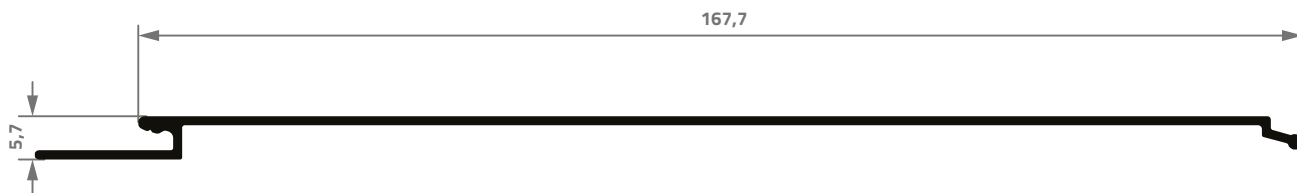

LB-036
0,592 Kg/m

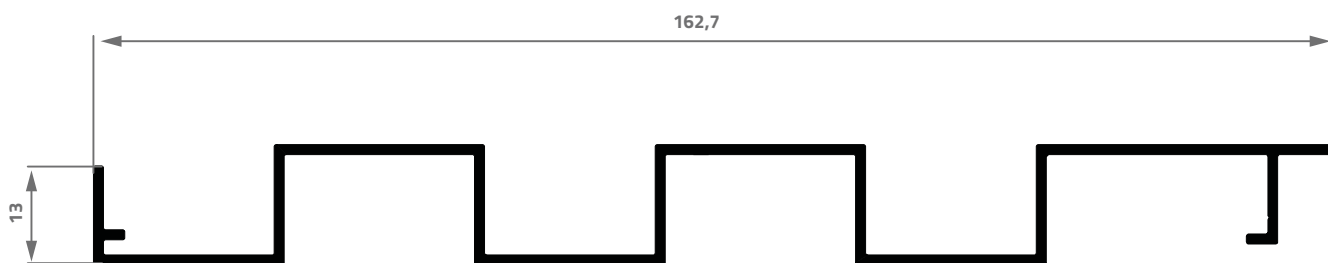

LB-075
0,931 Kg/m



LINHA 25

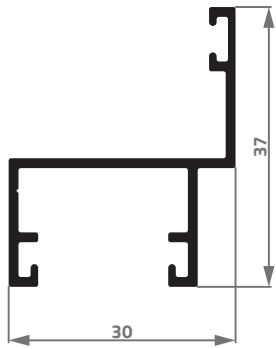

25002
0,339 Kg/m

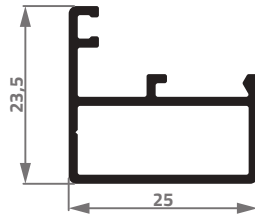

25001
0,308 Kg/m

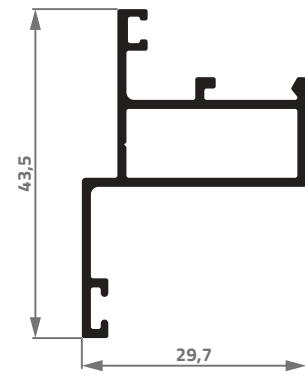

25005
0,416 Kg/m

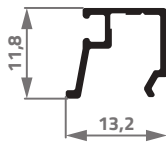

BG-001
0,089 Kg/m

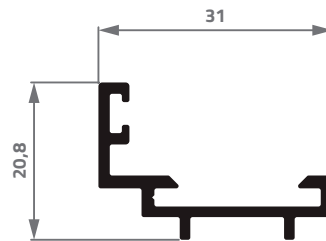

25548
0,282 Kg/m

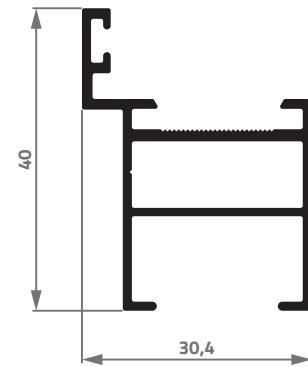

25540
0,472 Kg/m

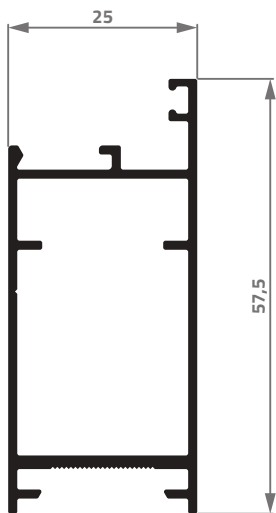

25542
0,601 Kg/m

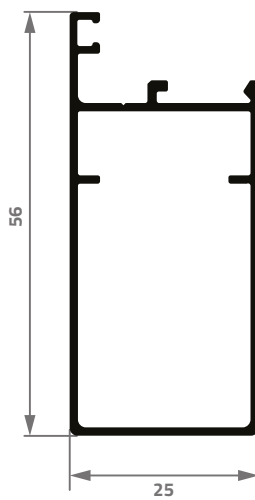

25504L
0,497 Kg/m

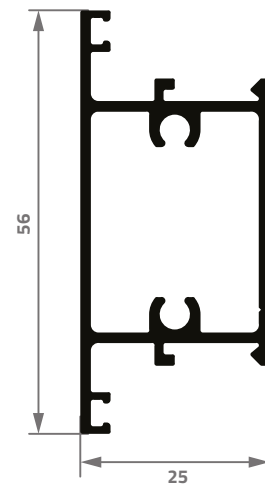

25508
0,692 Kg/m



LINHA FACHADA

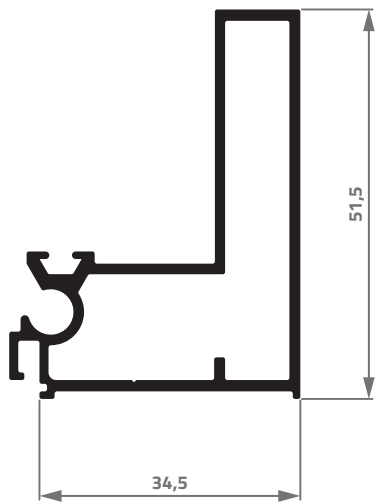

XA-245
0,744 Kg/m

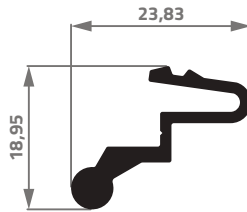

XA-227
0,264 Kg/m

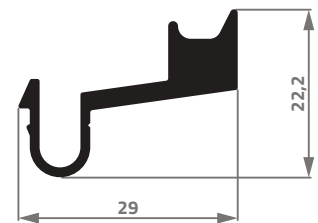

XA-231
0,387 Kg/m

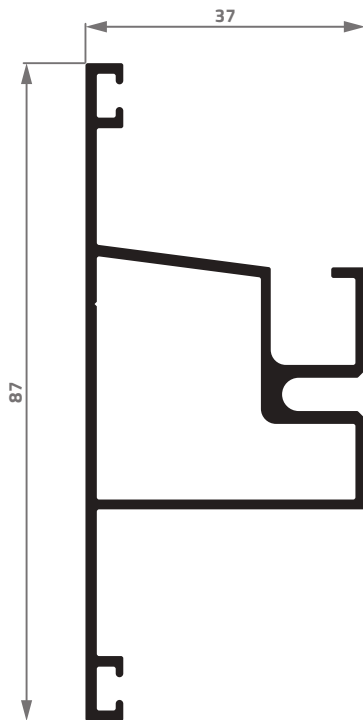

XA-211
0,937 Kg/m

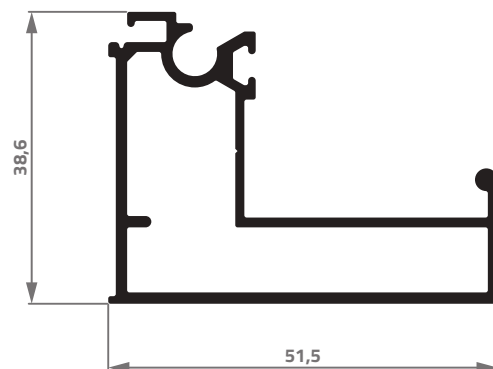

XA-230
0,769 Kg/m

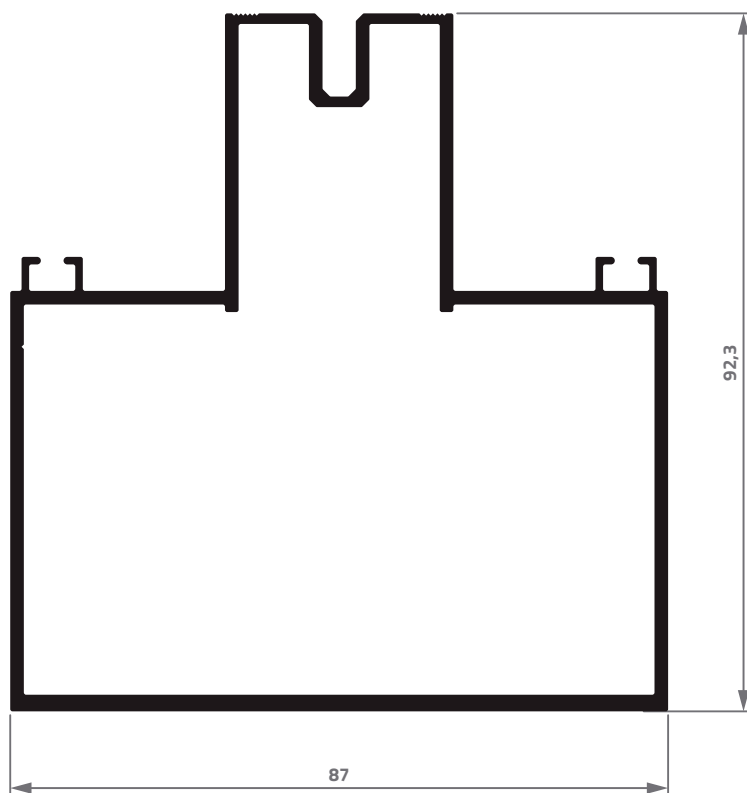

XA-200
1,952 Kg/m

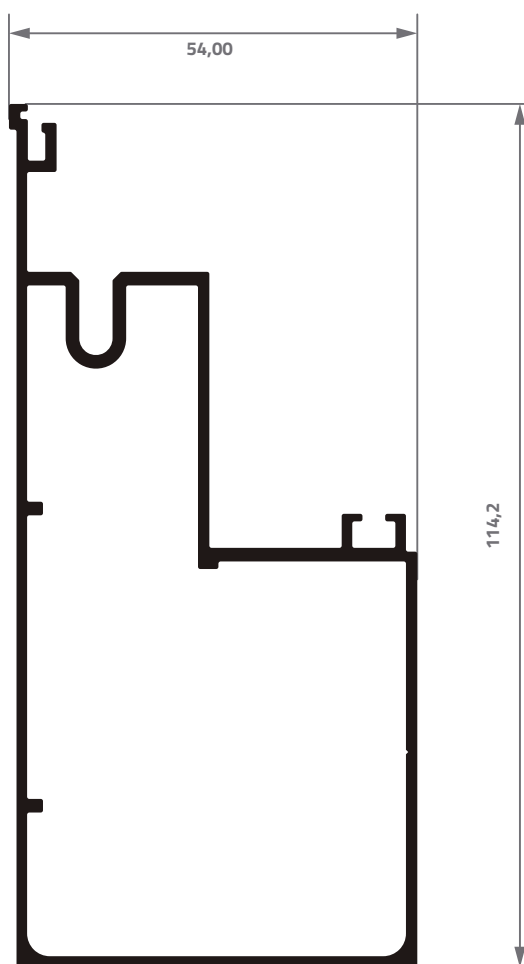

XA-515
1,479 Kg/m

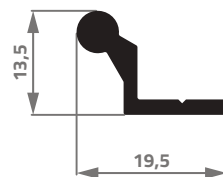

XA-247
0,191 Kg/m



LINHA INTEGRADA

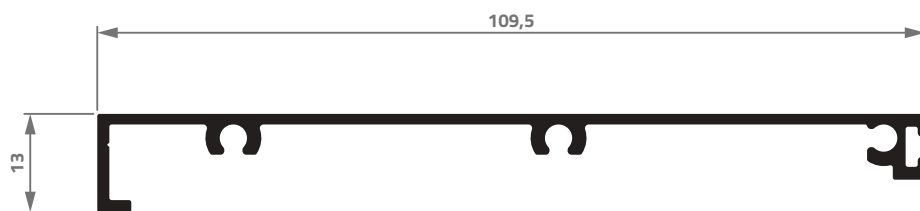

MN-002
0,640 Kg/m

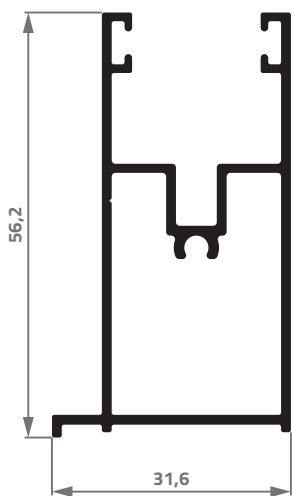

MN-007
0,705 Kg/m

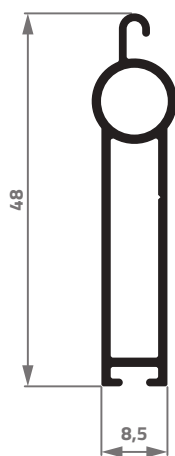

MN-055
0,366 Kg/m

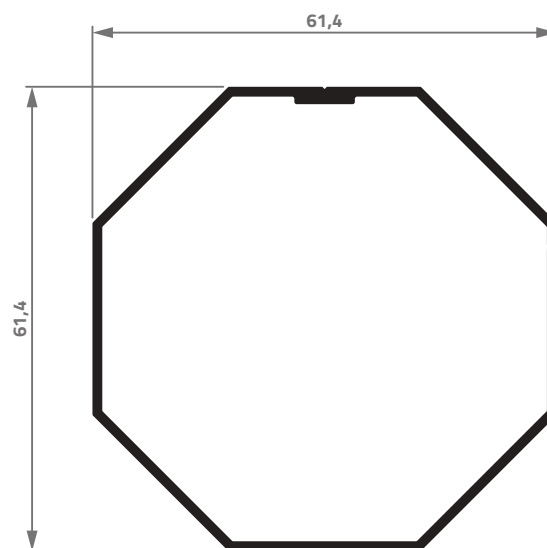

MN-015
0,723 Kg/m

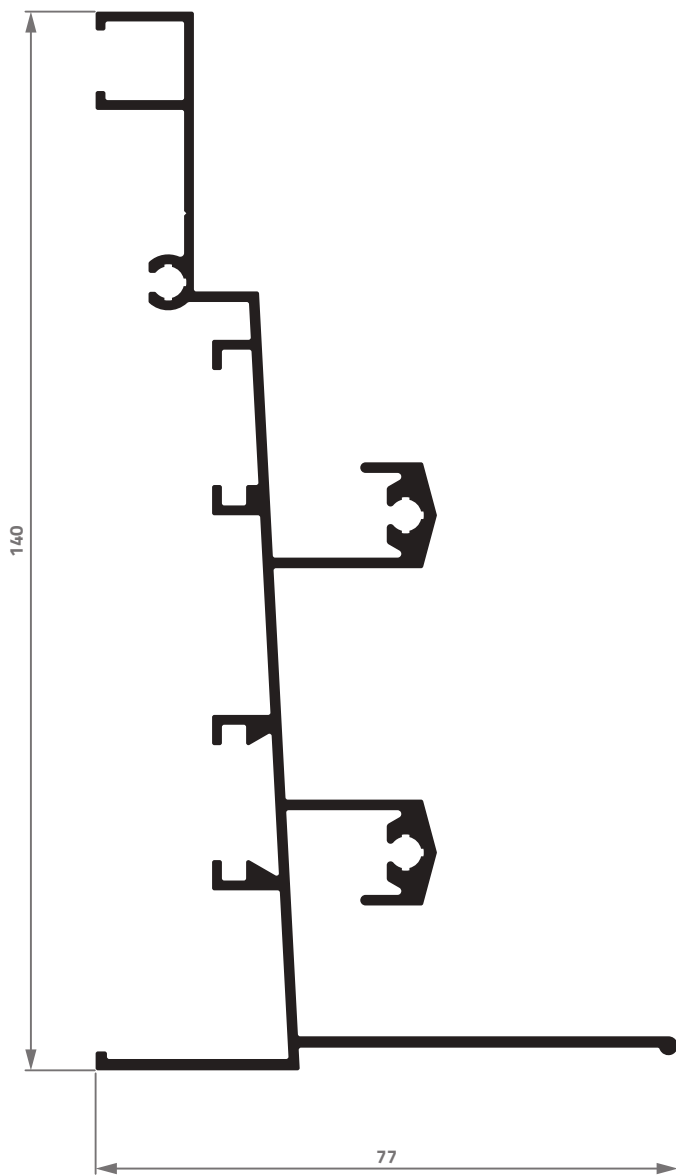

MN-030
1,643 Kg/m

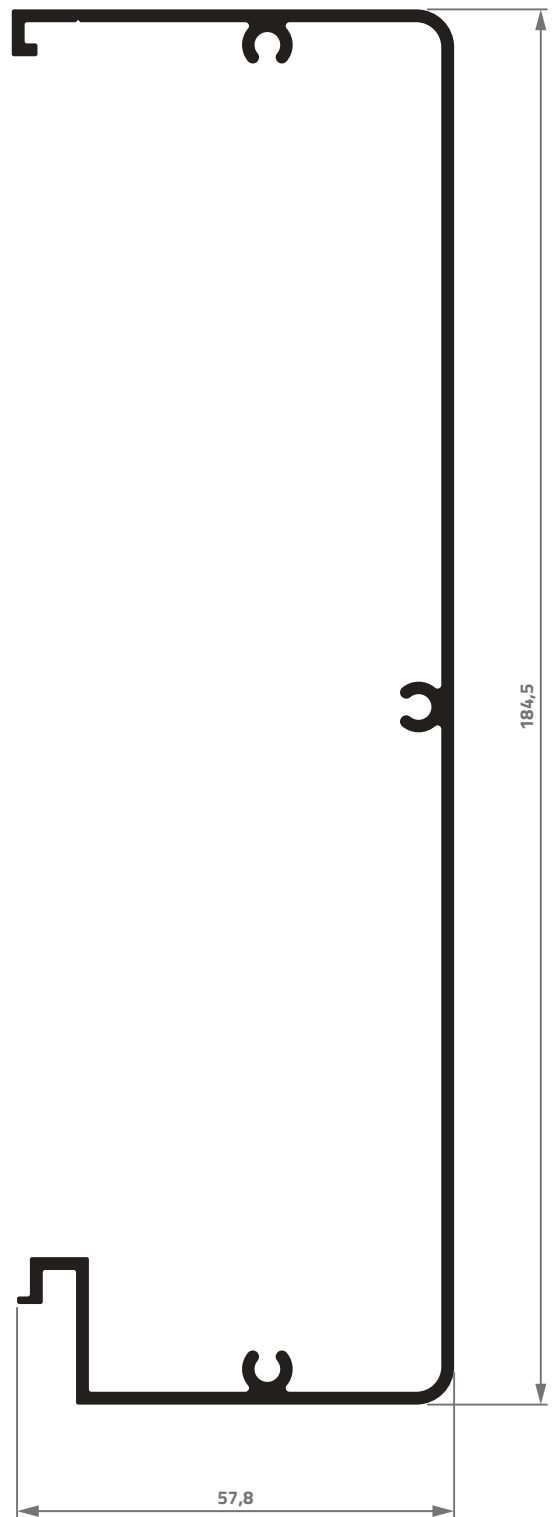

MN-032
1,653 Kg/m

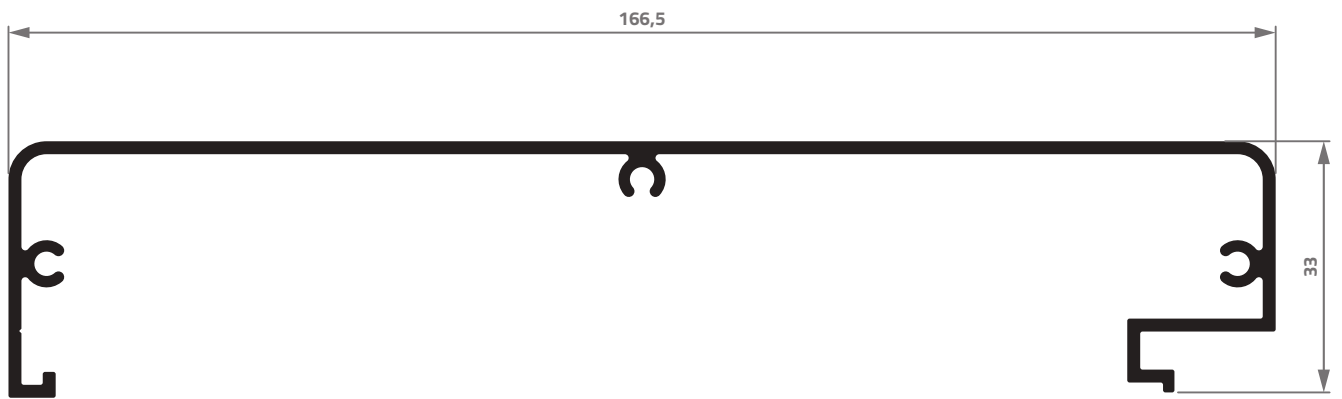

MN-031
1,330 Kg/m

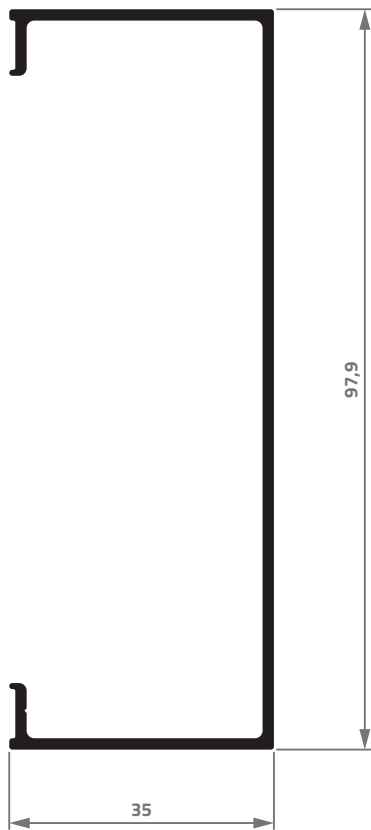

MN-050
0,733 Kg/m

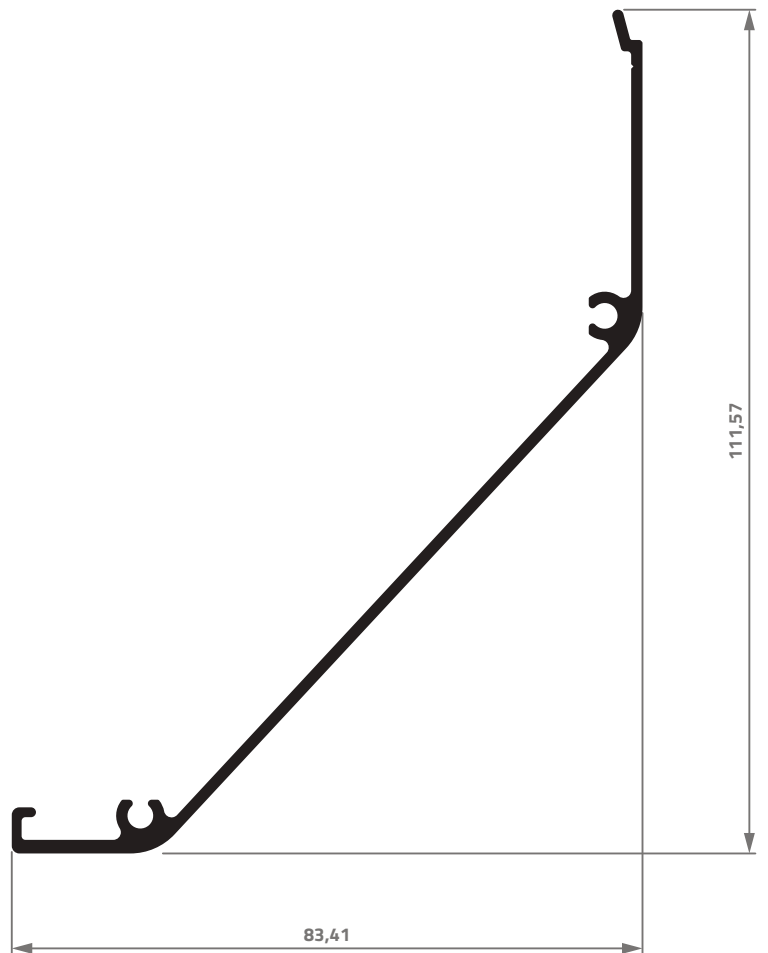

MN-005
0,784 Kg/m

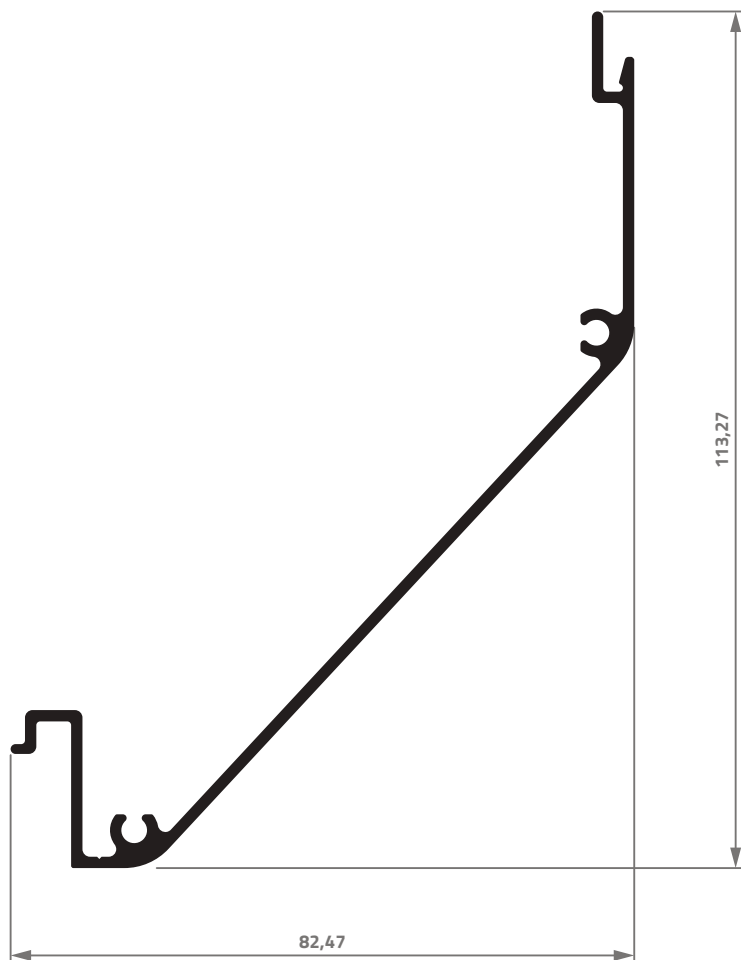

MN-006
0,878 Kg/m

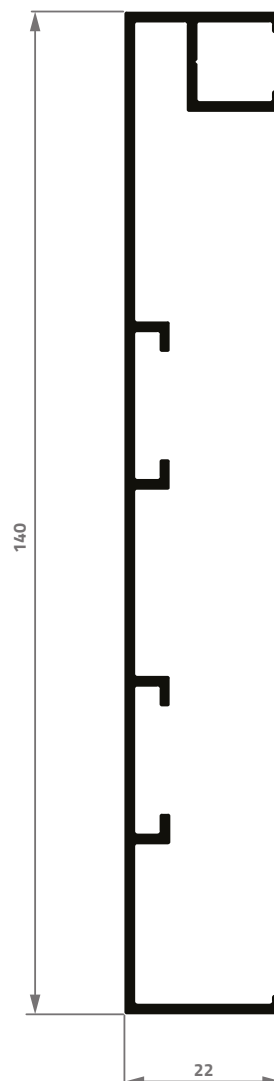

MN-003
0,971 Kg/m

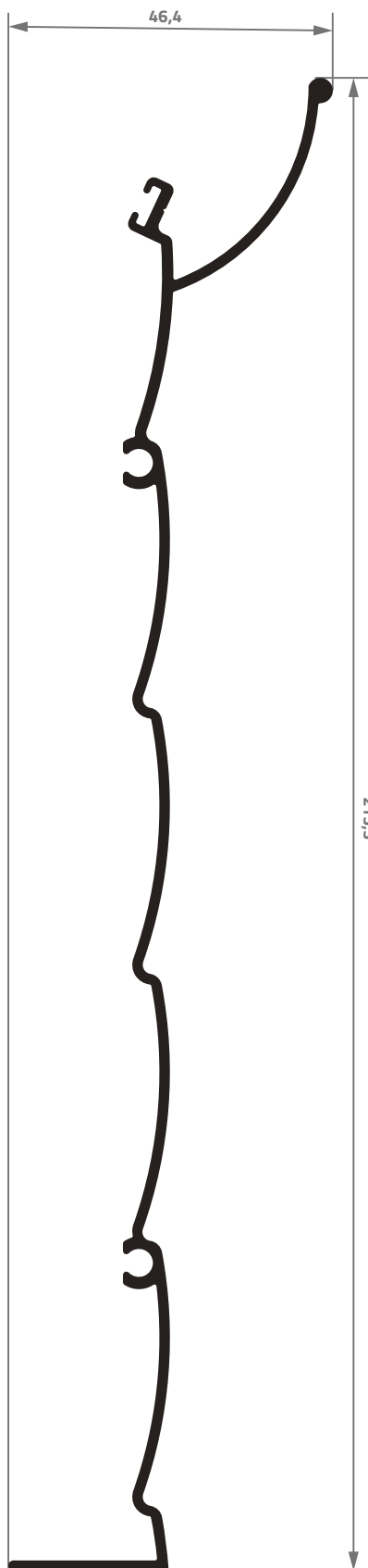

MN-039
1,215 Kg/m

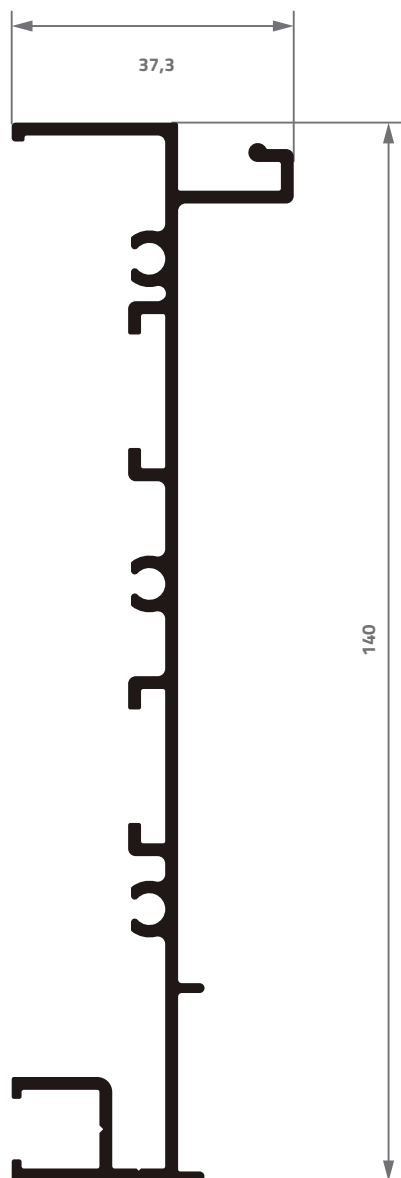

MN-001
1,375 Kg/m

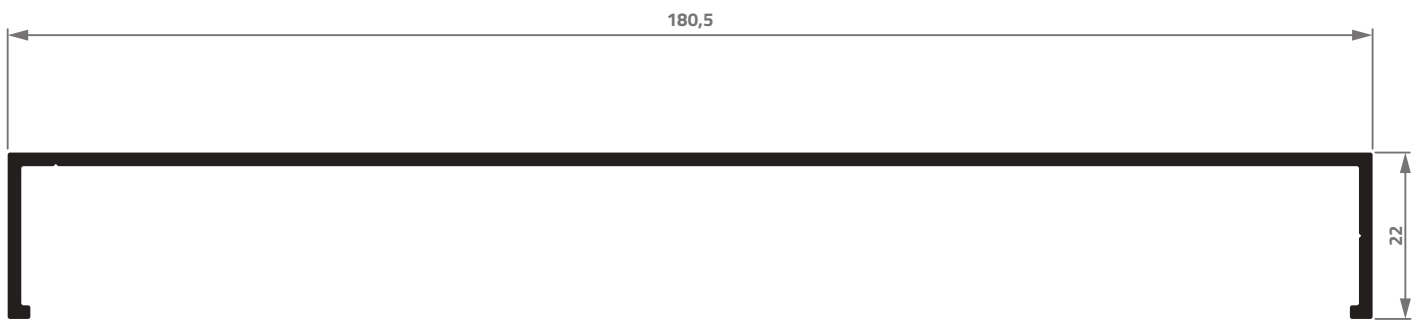

AG-035
1,089 Kg/m

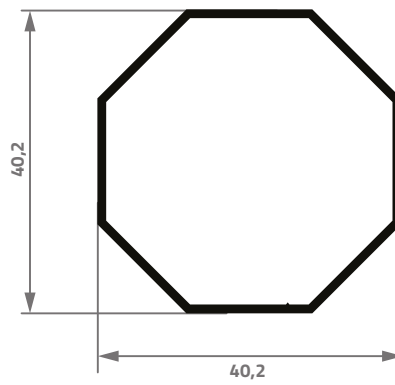

MN-014
0,420 Kg/m



PORTÕES



PC-602
1,174 Kg/m

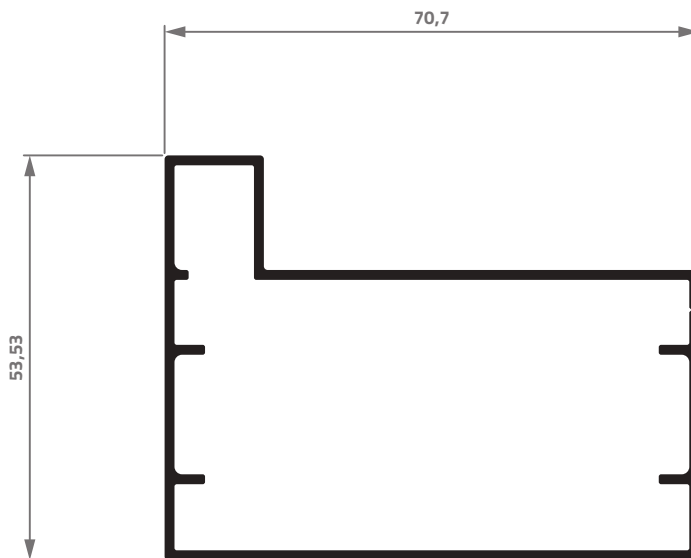

PC-010
0,929 Kg/m

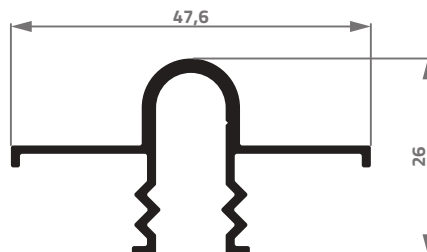

PC-006
0,386 Kg/m

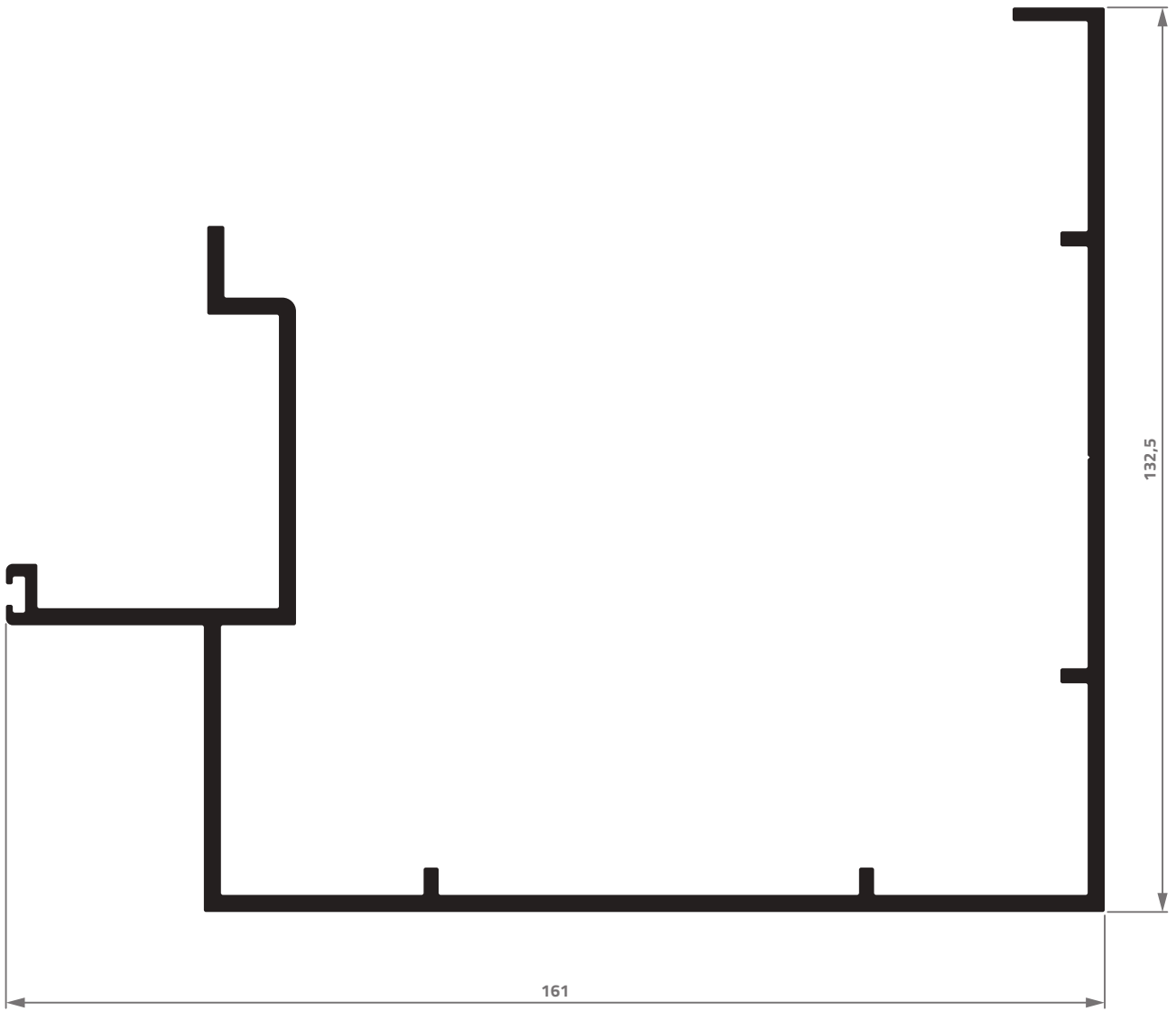

PC-601
2,979 Kg/m



SACADAS



FSC-500
1,054 Kg/m

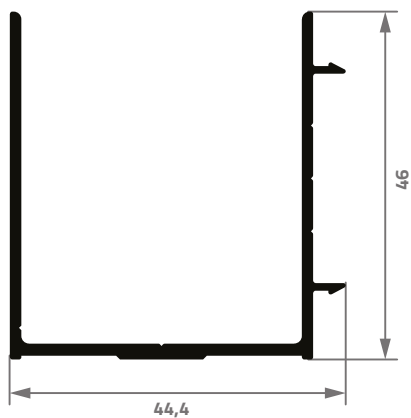

FSC-502
0,573 Kg/m

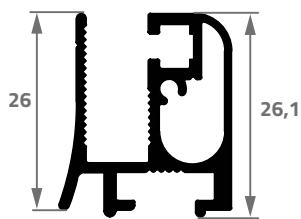

CEG-231
0,443 Kg/m

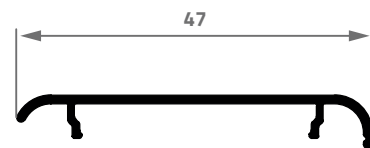

CEG-222
0,187 Kg/m

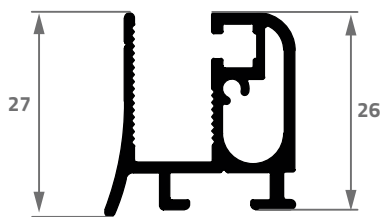

CEG-238
0,471 Kg/m

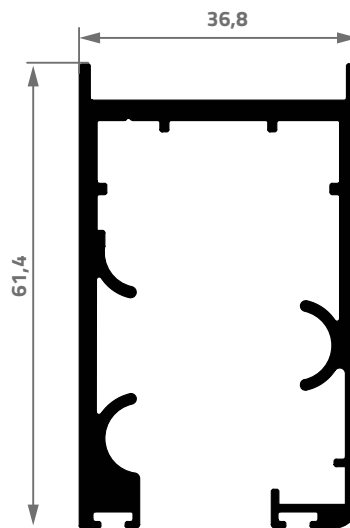

CEG-233
1,266 Kg/m

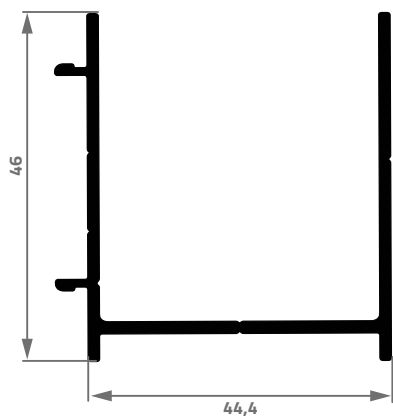

CEG-235
0,563 Kg/m

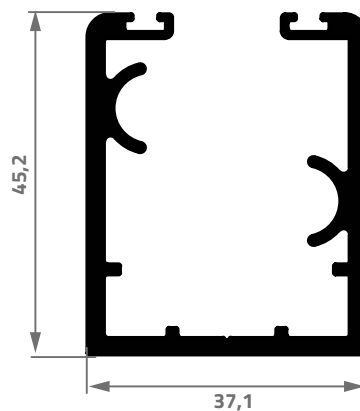

CEG-500
1,050 Kg/m



TELHADOS

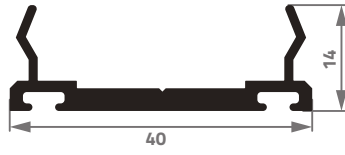

FC-014
0,381 Kg/m

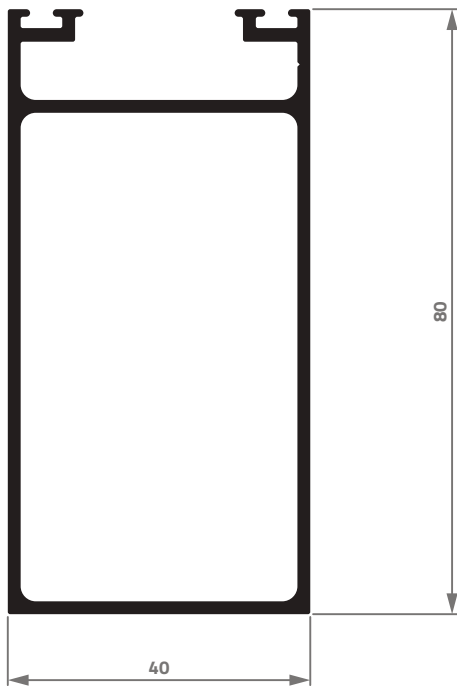

FC-012
1,200 Kg/m

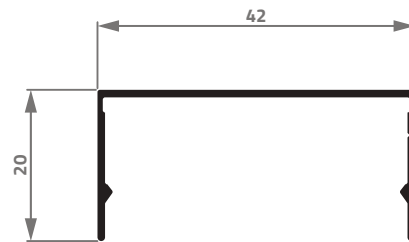

FC-013
0,221 Kg/m



TEMPERADOS 10MM

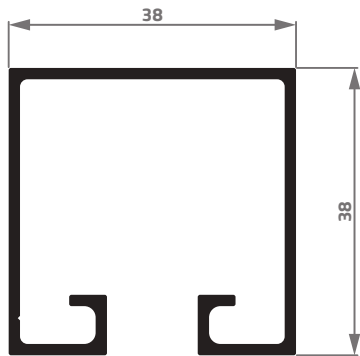

DS-314
0,737 Kg/m

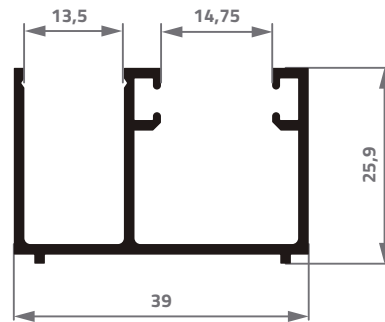

2935
0,438 Kg/m

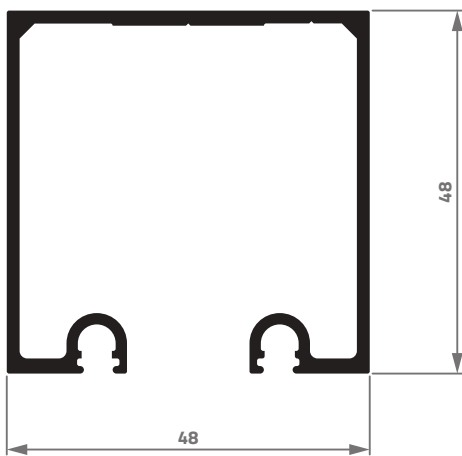

CX-124
0,900 Kg/m

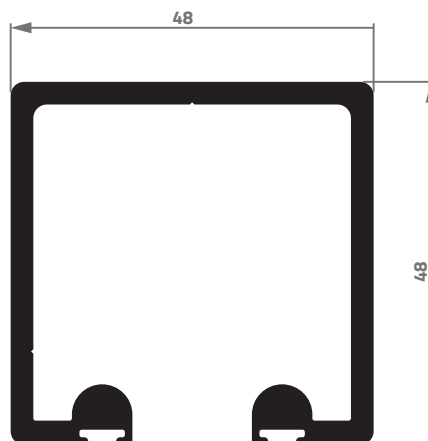

CX-125
1,462 Kg/m

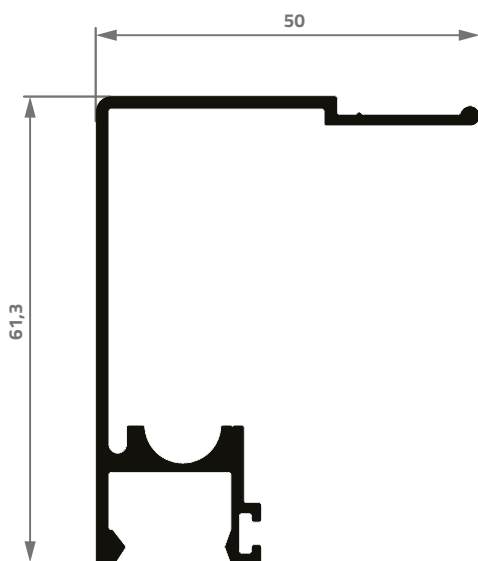

2910
0,773 Kg/m

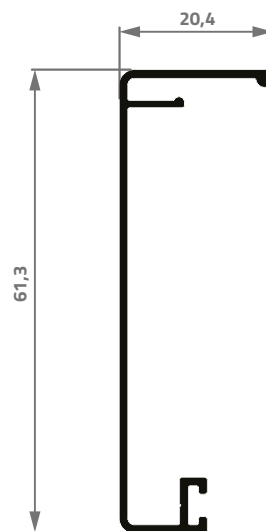

2911
0,325 Kg/m

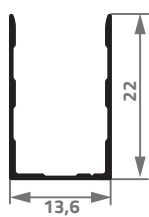

BX-129
0,117 Kg/m

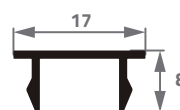

3074
0,095 Kg/m

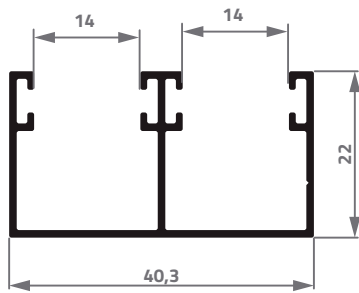

2939
0,354 Kg/m

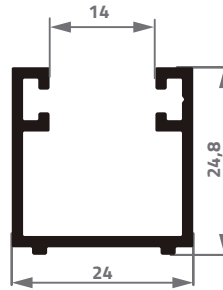

2936
0,365 Kg/m

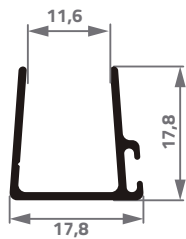

2937
0,163 Kg/m

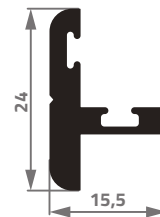

2938
0,331 Kg/m



TEMPERADOS 8MM

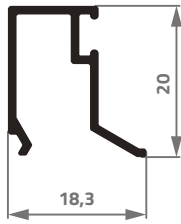

AL-027
0,160 Kg/m

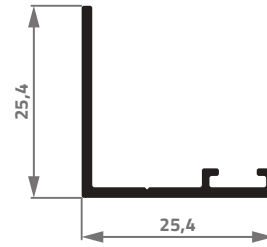

CT-016ESC
0,208 Kg/m

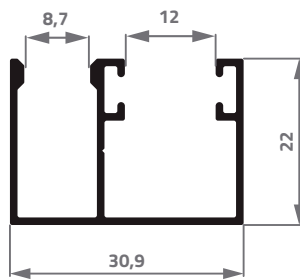

AL-75
0,315 Kg/m

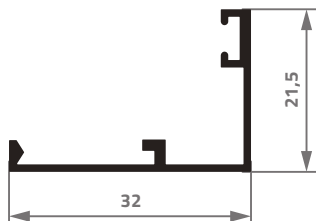

AL-026
0,227 Kg/m

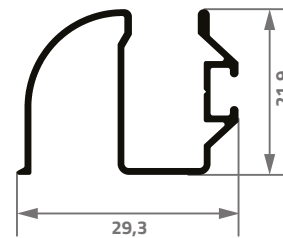

BX-059
0,243 Kg/m

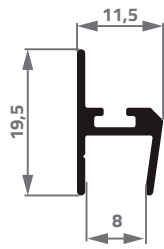

BX-104
0,149 Kg/m

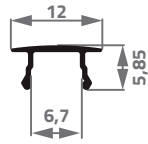

3075
0,056 Kg/m

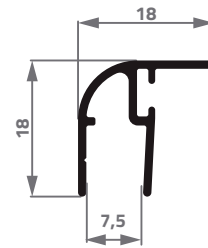

BX-093
0,164 Kg/m

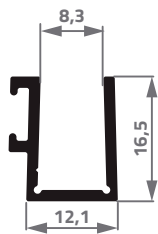

3172
0,193 Kg/m

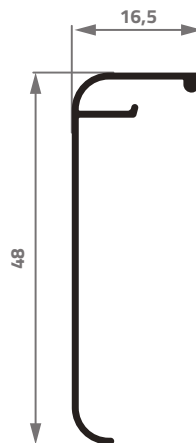

2911-BOX
0,208 Kg/m



PU-009
0,154 Kg/m

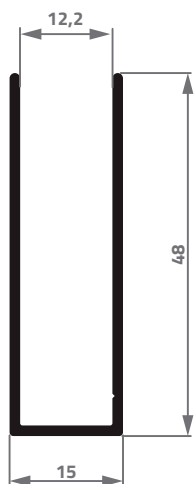

PU-048
0,409 Kg/m

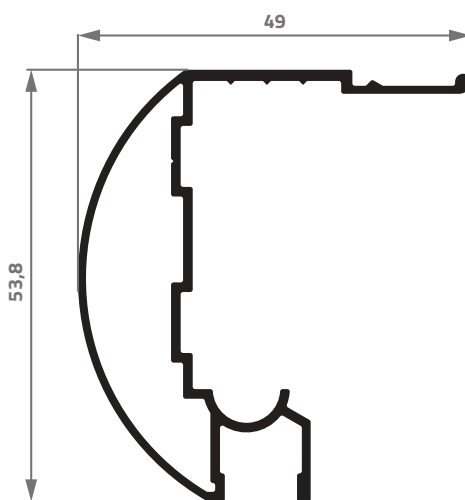

2910-BOX
0,607 Kg/m

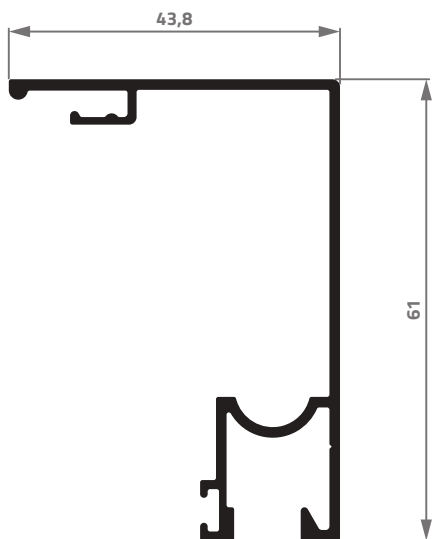

2910-L
0,632 Kg/m



2911-L
0,274 Kg/m



PU-009L
0,111 Kg/m

The image features a minimalist, abstract design. A central horizontal red bar with rounded ends contains the word "VENEZIANAS" in white, uppercase, sans-serif font. The background is white, accented with several geometric shapes: a cluster of red and black triangles in the top-left corner, a red bar extending from the top-right, and another cluster of red and black triangles in the bottom-right corner. A red bar also extends from the bottom-left corner.

VENEZIANAS

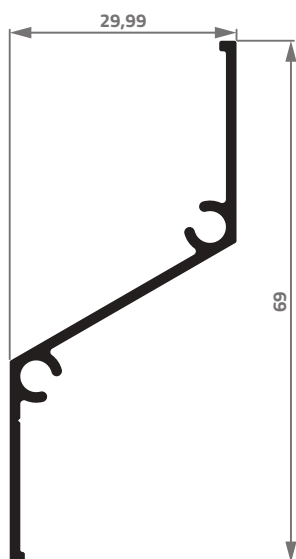

VZ-060
0,377 Kg/m

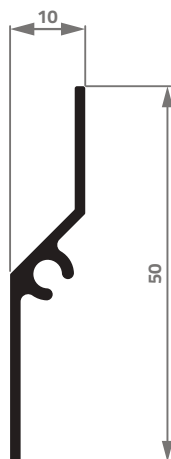

DV-113
0,253 Kg/m

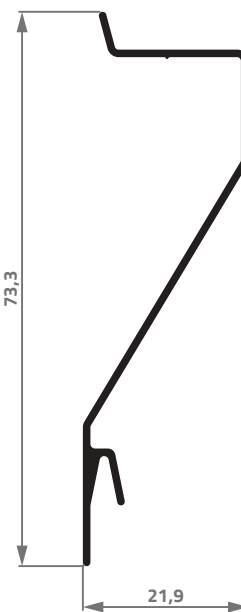

VZ-006
0,304 Kg/m

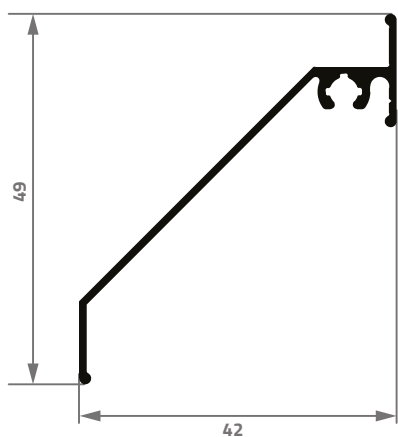

VZ-047
0,268 Kg/m



VZ-024
0,231 Kg/m

ALUVIK.COM.BR



 (48) 3300-0992

 contato@aluvik.com.br

 Avenida Thiago Antunes Teixeira, S/N Galpão
Lote 9G, Quadra F Bela Vista – Palhoça/SC

